

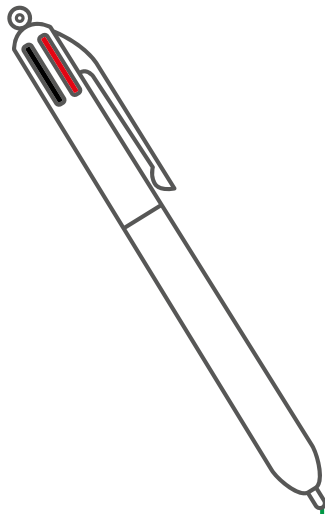

Your Brand Ambassador



POUR DES
MARQUES
COLORÉES ET
ENGAGÉES POUR
LA PLANÈTE

2021
CATALOGUE GÉNÉRAL

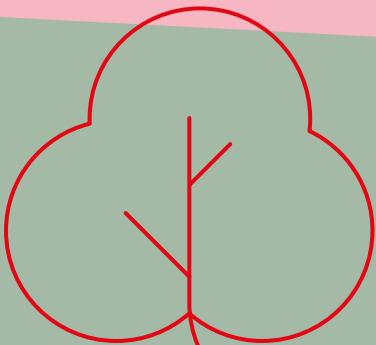
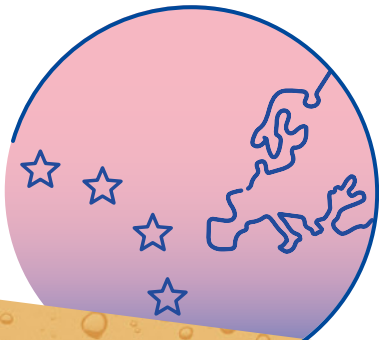

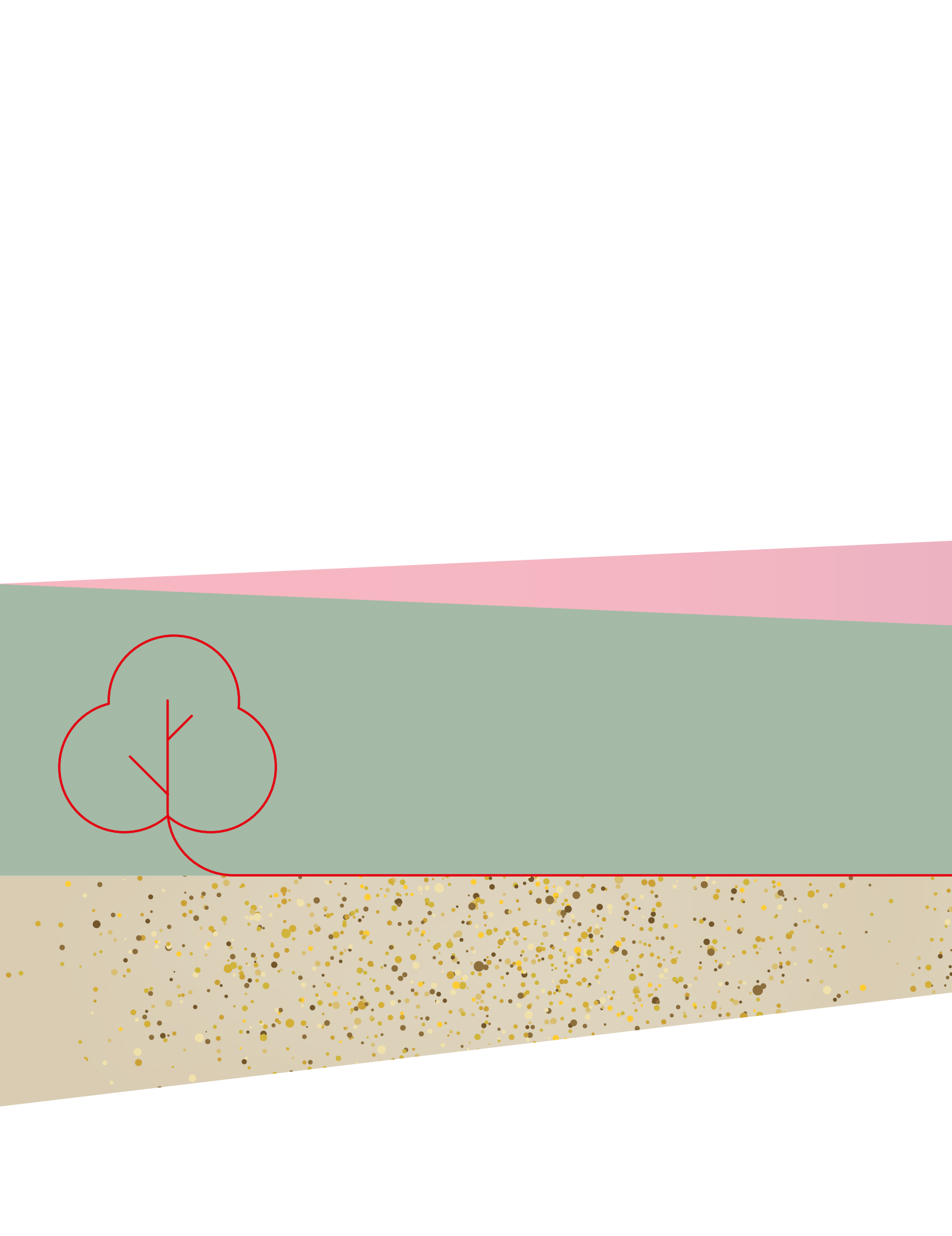

Depuis des années, BIC apporte simplicité et joie au quotidien en concevant des produits qui font partie de nos vies. Nous pensons avoir un impact positif sur le monde en offrant des solutions perennes qui grâce à une conception intelligente et à la création de produits de haute qualité et durables, respectent la planète.

Avec plus de 50 ans d'expérience dans l'impression et pionnier de la communication couleur, BIC Graphic transforme les produits emblématiques BIC® en de puissants outils de communication. Vous pouvez être sûr que votre marque est entre les mains d'un expert qui prend soin de la planète.

Parce que ... Quoi de mieux qu'une vraie marque pour promouvoir la vôtre ?

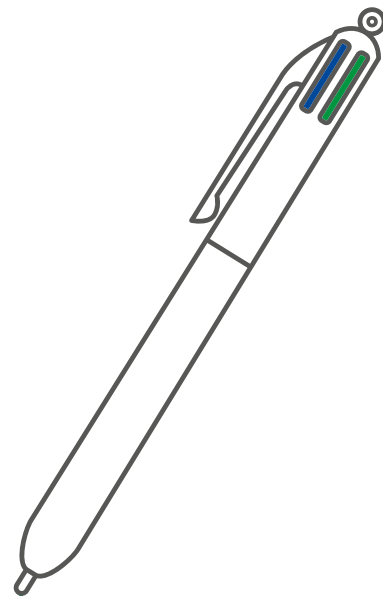

DURABILITÉ, COULEURS, TEXTURES ET INNOVATION

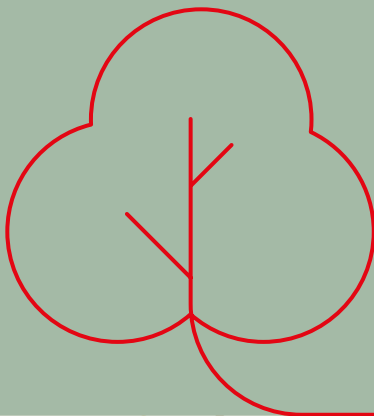

IMPACT FAIBLE SUR L'ENVIRONNEMENT

Nous produisons et
imprimons à proximité
de nos clients



IMPRESSION EN EUROPE

100% de nos
instruments d'écriture
et briquets



CONFORMITÉ DES NORMES

Normes mondialement
reconnues sur les contrôles
qualité

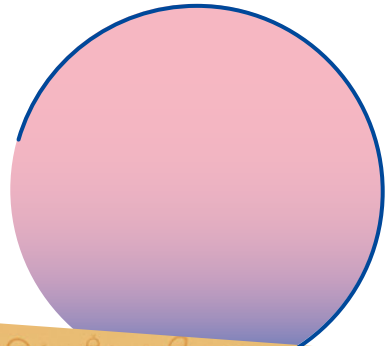
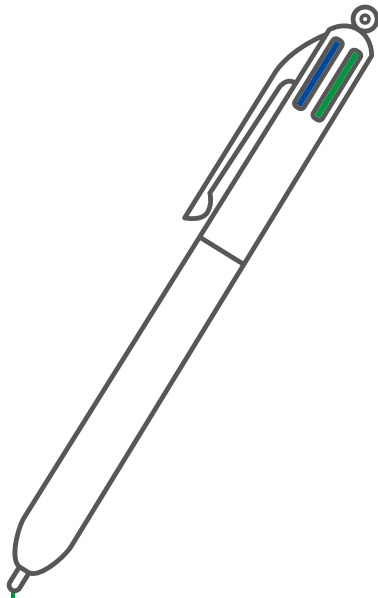

Nous proposons pour votre marque une large gamme de couleurs et textures



MIX & MATCH

Plus de 100,000 combinaisons de couleurs standards gratuites et des couleurs faites sur mesure !



EXPERTISE EN MATIERE D'IMPRESSION

Plus de 50 ans d'expérience dans le domaine de l'impression



PIONNIER DE L'INNOVATION

Technologies d'impressions les plus récentes



OUTILS NUMÉRIQUES



SOMMAIRE

A PROPOS DE NOUS	6
GAMME ANTIBACTÉRIENNE BGUARD	20
GAMME BRITEPIX™ DIGITAL	22
GAMME DÉVELOPPEMENT DURABLE ECOLUTIONS®	16

INSTRUMENTS D'ÉCRITURE BIC®

STYLOS	26
STYLOS MÉTALLIQUES	112
ROLLERS ET GELS	118
SURLIGNEURS ET MARQUEURS	126
CRAYONS	136
SPROUT	147

AUTRES INSTRUMENTS D'ÉCRITURE

STYLOS	150
STYLOS STYLUS	156

NOTES ADHESIVES BIC®

BLOC-NOTES ADHÉSIFS	162
BOOKLETS ET SCRATCH PADS	180

BRIQUETS ET COQUES BIC®

BRIQUETS	204
COQUES DE BRIQUETS	226
AUTRES PRODUITS	232

EMBALLAGE SPÉCIAL BIC®

INSTRUMENTS D'ECRITURE	236
BRIQUETS	240

INFORMATIONS GÉNÉRALES

COMMANDEZ EN TOUTE SIMPLICITÉ!	242
SERVICE D'IMPRESSION EN 48 HEURES	243
INFORMATIONS GÉNÉRALES SUR LES NOTES ADHÉSIVES	244
SYMBOLES ET ABRÉVIATIONS	245
INFORMATIONS GÉNÉRALES	246
INDEX PRODUITS	248
NUANCIER DE COULEURS	249



ALLER À L'ESSENTIEL POUR CRÉER ET PARTAGER DE LA VALEUR DANS LA DURÉE

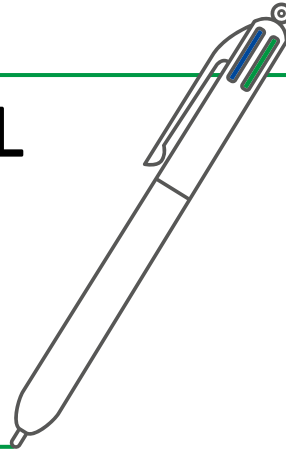

POSITIONNEMENT

Des produits essentiels pour la vie quotidienne
des consommateurs du monde entier



HAUTE QUALITÉ

En créant son premier produit, le stylo à bille BIC® Cristal®, BIC a choisi d'aller à l'essentiel : concevoir un outil simple et de haute qualité vendu au prix juste, qui facilite un geste quotidien et qui puisse être utilisé par tous, partout dans le monde.



INVENTIF

BIC a évolué en répondant de manière efficace à l'évolution des attentes des consommateurs. Nos équipes de R&D travaillent de manière proactive pour identifier leurs besoins et trouver des solutions ingénieuses pour optimiser les performances de nos produits.



FIABLE

La meilleure façon de fidéliser le consommateur est d'offrir la même haute qualité d'usage du début à la fin du produit : plus de 2 km d'écriture pour un stylo à bille BIC® Cristal®, 3 000 flammes constantes pour un briquet de poche BIC® Maxi et 17 rasages pour un rasoir BIC® Flex 3.



DURABLE

Nous nous sommes toujours efforcés de créer des produits qui durent longtemps, avec une faible empreinte environnementale et fabriqués avec un minimum de ressources. Nous utilisons une approche d'éco-conception qui intègre dans de nombreux produits des solutions alternatives telles que l'utilisation de matériaux recyclés ou de bioplastiques.

31 MILLIONS

DE PRODUITS CHOISIS CHAQUE
JOUR DANS LE MONDE



19,1

millions
d'articles de
papeterie BIC®
achetés chaque
jour.



4,3

millions de
briquets
BIC® achetés
chaque
jour.

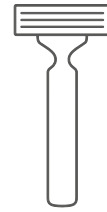

7,1

millions de
rasoirs BIC®
achetés
chaque
jour.

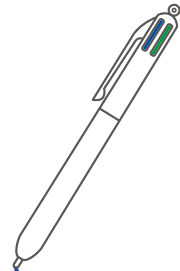

LEADER MONDIAL SUR 3 CATÉGORIES DE PRODUITS

PAPETERIE

7250 kilomètres : la longueur des tests d'écriture réalisés en 2015 sur des lots de stylos à bille, de stylos gel et de rollers

BRIQUETS

Dans l'usine des briquets BIC, un quart du temps de travail quotidien d'un opérateur est dédié au contrôle qualité.

RASOIRS

30 tests de contrôles sont réalisés pour fabriquer les rasoirs 3, 4 ou 5 lames pour répondre aux exigences des standards qualité BIC.

VISION, MISSION ET VALEURS DE BIC



VISION

Simplifier et
enchanter le
quotidien.

MISSION

Créer des produits
essentiels, de
grande qualité, sûrs,
abordables et dans
lesquels chacun a
confiance.

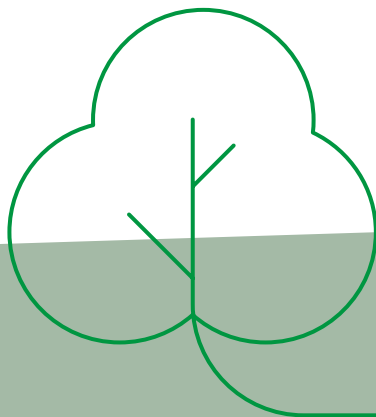

VALEURS

Intégrité,
responsabilité,
durabilité et
simplicité, ingéniosité,
travail d'équipe.

FABRICATION INTERNATIONALE

25 USINES SUR 4 CONTINENTS*

92% des produits BIC® sont fabriqués dans nos propres usines

100% des instruments d'écriture et briquets de BIC Graphic sont marqués sur notre site de production en Espagne



Papeterie*
(16 usines)



Briquets
(5 usines)



Rasoirs
(4 usines)



25

Usines à travers le monde



160

Pays dans lesquels des produits BIC® sont disponibles



12,777

Employés dans le monde



4 millions

Points de vente

Mis à jour le 31 juillet 2020
* Y compris BIC Graphic

LA FONDATION d'ENTREPRISE BIC

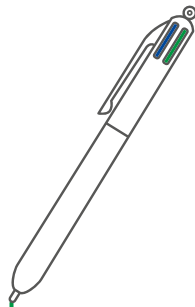

Chez BIC, nous croyons sincèrement que l'éducation a le pouvoir de changer le monde. C'est pour cette raison qu'en 2016, nous avons créé la Fondation d'entreprise BIC, afin de soutenir des projets de lutte contre le décrochage scolaire, d'œuvrer pour un meilleur accès à l'éducation des filles et des femmes, et de développer l'éducation à l'environnement. Nous nous intéressons également aux projets qui favorisent l'entrepreneuriat social et développent les enfants et les jeunes par l'éducation, leur permettant ainsi de réussir leurs projets de vie et de faire face aux défis de ce monde en constante évolution.



La semaine mondiale pour l'éducation

Chaque année, la Semaine Mondiale de l'Éducation est l'occasion pour les membres de des équipes BIC de contribuer collectivement à notre objectif commun d'améliorer d'ici 2025 les conditions d'apprentissage de 250 millions d'enfants dans le monde. L'année dernière, dans 50 pays, ils ont contribué à améliorer les conditions d'apprentissage de plus de 61 millions d'enfants !



En 2020, le Prix BIC Cristal a reçu un soutien incroyable avec des centaines de nominations émanant des collaborateurs de BIC ! Le jury a sélectionné 10 éducateurs méritants représentant chaque région où BIC opère. Chaque gagnant recevra un prix personnalisé et son école ou son organisation une bourse de 5 000 euros et un don d'articles de papeterie BIC.

2025 : ENGAGEMENTS POUR UN DÉVELOPPEMENT DURABLE

Notre vision s'exprime par notre signature "Ecrire le futur, ensemble", englobant 5 engagements ambitieux en accord avec la stratégie du groupe.

1 FAVORISER L'INNOVATION DURABLE DANS LES PRODUITS BIC®

2 AGIR CONTRE LE CHANGEMENT CLIMATIQUE

3 S'ENGAGER POUR LA SECURITE AU TRAVAIL

4 IMPLIQUER LES FOURNISSEURS DE MANIÈRE PROACTIVE

5 S'INVESTIR POUR UNE VIE MEILLEURE À TRAVERS L'EDUCATION

RÉDUIRE L'IMPACT DE NOS PRODUITS

BIC Ecolutions est une gamme de produits d'écriture fabriqués à partir de matériaux recyclés.

ecolutions®

En s'engageant à donner une seconde vie à nos produits

Ubicuity™ : UN MODÈLE D'ÉCONOMIE CIRCULAIRE UNIQUE



1. Collecte des instruments d'écriture usagés. **Terracycle®**.
2. Matériaux transformés en planches. **Govaplast**.
3. Planches transformées en mobilier urbain. **Plas Eco**

Grâce à Ubicuity, 100% de nos produits d'écritures BIC sont recyclables.

LA RESPONSABILITÉ SOCIALE ET ENVIRONNEMENTALE DE BIC GRAPHIC

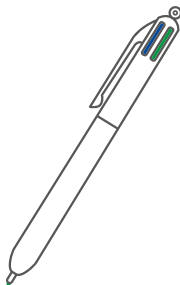

ISO
CERTIFIED
ISO 9001 - ISO 14001



UN SCORE
DE 0 NON-
CONFORMITÉ



MEMBRE DE
AMFORI, AUDITE PAR
BSCI



MEMBRE DE SEDEX,
AUDITE PAR
SMETA



MEMBRE DE
UN GLOBAL
COMPACT

ecovadis

PRIX
EN OR



DES SITES WEB AU
BILAN
CARBONE NEUTRE

Intertek



AUDITE PAR WCA



QUALIFIÉ PAR
IMPRIM' VERT.

Apprenez-en plus sur: <https://www.bicgraphic.eu/ie/sustainable-development.html>

NOS PRIX

POUR LA TROISIÈME ANNÉE CONSÉCUTIVE 2017-2019



2017
1e PLACE
Excellence Économique
1e PLACE
Produits durables

2018
1e PLACE
Initiative sociale
3e PLACE
Initiative pour
l'environnement

2019
1e PLACE
Excellence
Économique

AVANTAGES DE BIC GRAPHIC

MARQUE BIC®

La marque BIC® est reconnue par 9 personnes sur 10 !

GRATUIT !

Coûts de préparation, maquettes virtuelles, préparation de bon à tirer, échantillons, apps et outils numériques, etc.

MIX & MATCH

Plus de 10.000 combinaisons possibles d'attributs dans des coloris standards et sans frais supplémentaires

EXPERTISE EN MATIÈRE D'IMPRESSION

Plus de 50 ans d'expérience dans le domaine de l'impression

INNOVATION

Pionniers dans le domaine des technologies d'impression dernière génération

SERVICE D'IMPRESSION EN 48 HEURES GRATUIT !

Plus de 100 produits !

DEVELOPPEMENT DURABLE

L'usine et nos installations d'impression BIC Graphic de Tarragone sont alimentées avec de l'électricité 100% renouvelable.

PROCHE DE NOS CLIENTS

Fabriqués et imprimés en Europe

GARANTIE STOCK

Des centaines d'articles toujours en stock.

OUTILS DIGITAUX ET APPS

www.bicgraphic.eu



TECHNIQUES D'IMPRESSION BIC GRAPHIC

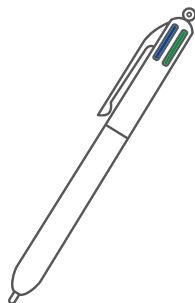

Sérigraphie

(y compris les
encres en relief et
métalliques)



Brite Pix™



Tampographie



Texture britePix™



**Impression
numérique**



Numérique britePix™



Impression relief 3D



Encre métallisée



Gravure laser

**Nos encres sont conformes aux
réglementations européennes.**

- 5 tests distincts :
Test d'adhérence, Test de résistance aux rayures (ISO 12137:11), Test d'abrasion, Test de résistance, Test d'exposition à la transpiration par simulation
- Chaque commande de produits imprimés passe 4 contrôles distincts :
Contrôle de l'esthétique, Contrôle de la couleur de l'impression,
Contrôle de l'adhérence de l'impression, Résistance à la détérioration



**La garantie
de plus de 50 ans
d'expérience**

OUTILS DIGITAUX DE BIC GRAPHIC, VOS PARTENAIRES OÙ QUE VOUS SOYEZ

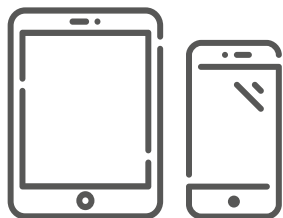
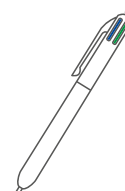

C'est la raison pour laquelle nos outils sont faits pour vous aider !

L'APP E-CATALOGUE BIC GRAPHIC

Unique permettant d'accéder à toutes les informations.

Créez vos propres notes et configurez également vos préférences d'affichage.

L'APP BIC GRAPHIC

- Réalité augmentée avec des effets surprenants
- Configurateur produit 3D
- Regardez les vidéos des produits
- Customisez vos images avec le service de personnalisation

BOUTIQUE EN LIGNE

www.bicgraphic.eu



Assistance en ligne
chat en direct

CONFIGURATEUR PRODUIT :

configurateur 2D et 3D pour tous les produits. Téléchargez votre logo et obtenez une maquette virtuelle.

3% DE REMISE

Obtenez 3% de remise sur chaque commande en ligne

SITES WEB AU BILAN CARBONE NEUTRE :

nous prenons part à l'initiative de développement durable en collaboration avec Global Climate Institute.



PRIX TOUT INCLUS :

frais techniques, impression et coût de transport.

E-DEVIS :

Toutes les informations requises en un seul click !

BIC GRAPHIC ENGAGÉ POUR L'ENVIRONNEMENT

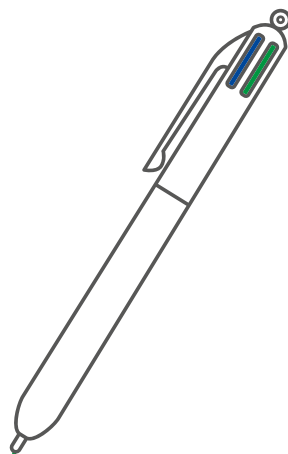

BIC Graphic travaille pour proposer des produits durables. Notre gamme Ecolutions est créée et basée sur 4 matières durables :

- Matières recyclées et recyclables
- Matières bio sourcées
- Papier à partir de forêts durables (FSC)
- Papier recyclé

Fabriqué à partir de déchets pharmaceutiques



Fabriqué à partir de caquettes plastiques de fruits et légumes



Fabriqué à partir de réfrigérateurs recyclés et de pots de yaourts usagés

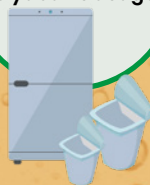

Fabriqué à partir d'éléments plastiques d'usines automobiles



Fait à partir de canne à sucre



FOREST STEWARDSHIP COUNCIL
Cartonnette FSC et recyclable



INSTRUMENTS D'ÉCRITURE ECO

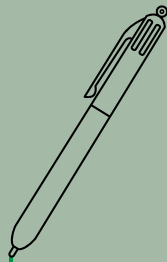

BIC MEDIA CLIC
BIO ECOLUTIONS®



page 52



BIC MEDIA CLIC
ECOLUTIONS®



page 45



BIC MEDIA CLIC
GRIP ECOLUTIONS®



page 45

BIC ROUND STIC®
ECOLUTIONS®



page 31

BIC CLIC STIC
ECOLUTIONS®



page 59

BIC SUPER CLIP
ECOLUTIONS®



page 71

BIC WIDE BODY
ECOLUTIONS®



page 84

BIC MATIC®
ECOLUTIONS®



page 137

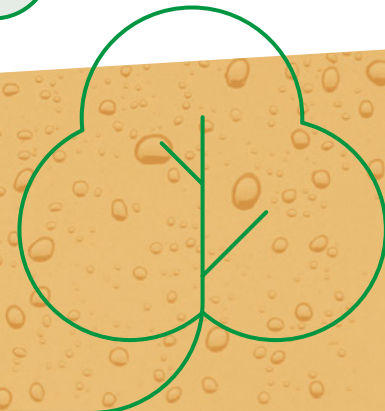

BIC EVOLUTION®
ECOLUTIONS®



page 141

BIC PERMANENT
MARKER ECOLUTIONS®



page 133

Sprout

Plant
Your
Pencil

The world's only
sustainable pencil that
you can plant after use
and grow into herbs,
vegetables or
flowers.

SPROUT®
GRAPHITE PENCIL



page 147

BIC® STICKY NOTES
ECOLUTIONS®



FABRIQUÉ À PARTIR DE 100% DE FIBRE RECYCLÉE
 ET 100% RECYCLABLE

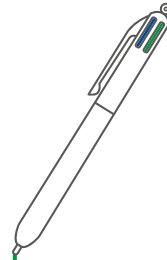

BIC® 50 MM X 75 MM ADHESIVE
 NOTEPADS ECOLUTIONS



BIC® 68 MM X 75 MM ADHESIVE
 NOTEPADS ECOLUTIONS®



BIC® 75 MM X 75 MM ADHESIVE
 NOTEPADS ECOLUTIONS®



BIC® 101 MM X 75 MM
 ADHESIVE NOTEPADS
 ECOLUTIONS®



BIC® 101 MM X 101 MM
 ADHESIVE NOTEPADS
 ECOLUTIONS®



BIC® 101 MM X 130 MM
 ADHESIVE NOTEPADS
 ECOLUTIONS®

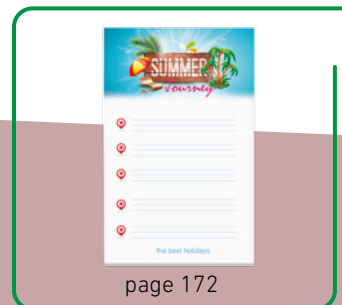

BIC® MEDIUM ADHESIVE DIE
 CUT NOTEPADS ECOLUTIONS®



BIC® SMALL ADHESIVE DIE CUT
 NOTEPADS ECOLUTIONS®

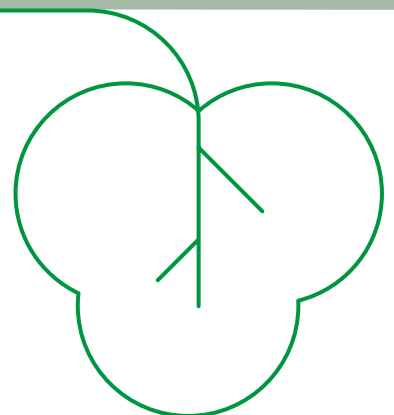

BIC® EMBALLAGE ECOLUTIONS®

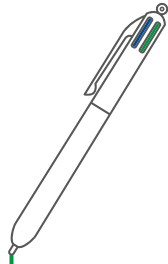

EMBALLAGE DURABLE Réduisez, Réutilisez, Recyclez

VALEUR ECOLOGIQUE

- Réduit et optimise le recyclage et les matériaux recyclés
- Réduit l'émission de carbone
- Conçu pour avoir des usages multiples.
- Contribue à la création d'une forêt BIC Graphic au Kenya.

VALEUR SOCIALE

- Soutien des projets agro-locaux pour les populations locales au Kenya grâce à la création d'une forêt BIC Graphic et Treedom®

MATÉRIAUX CERTIFIÉS

- Carton 100% recyclé
- Plastiques tels que PET, PP ou PS sont 100% recyclables
- Matières premières provenant de forêts durables (FSC)

BIC® MARKING SET



BIC® WINDOW BOX



BIC® PLASTIC POUCH



BIC® ECO SLEEVE



BIC® OUTER BOXES



TRAY OF 50 BIC® LIGHTERS



L'emballage portant le logo Treedom® contribue à la création d'une forêt BIC Graphic au Kenya. Nous vous remercions de votre soutien. Grâce à cette campagne, nous améliorons l'environnement (en réduisant les émissions de carbone) et nous pouvons soutenir les projets agroforestiers qui aident au développement des écosystèmes durables.



-90,100 KG CO₂

Les arbres que nous avons choisi de planter absorbent de l'atmosphère une quantité de CO₂ apte à remplir jusqu'à 469 camions !

BGUARD™
ANTIBACTERIAL PROTECTION

GAMME DE PRODUITS ANTIBACTÉRIENS

BIC GRAPHIC A DÉJÀ UNE EXPÉRIENCE
CONFIRMÉE DANS LES PRODUITS
ANTIBACTÉRIENS

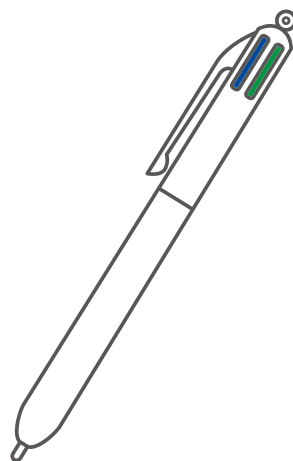

PRODUIT **BIOCIDE**

Classifié comme un produit biocide avec un effet antibactérien. **Testé.**

Utilisez les biocides avec précaution. Avant toute l'utilisation, lisez l'étiquette et les informations concernant le produit.

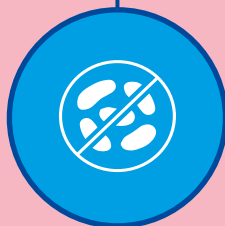

PROTECTION
BACTÉRIENNE



PROTECTION SUR
TOUTE LA SURFACE
DU STYLO

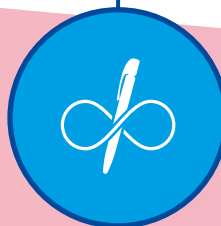

PROTECTION
À VIE



TESTÉ PAR UN
PROTOCOLE
ANTIBACTÉRIEN

Disponible dans certains pays uniquement.
Veuillez contacter votre attaché de clientèle pour plus d'information



Notre produit biocide élimine 99.9% des bactéries présentes sur la partie la plus exposée du stylo : le corps.

La protection est efficace sur l'ensemble du stylo et pour toute sa durée d'utilisation.



LES AUTRES STYLOS ANTIBACTÉRIENS

Les autres produits annoncent éviter la prolifération des germes signifiant ainsi que les germes apportés par l'utilisateur du stylo restent actives.

BGŪARD™



page 88

page 34

page 64

page 48

page 74

LE PREMIER
STYLO STYLUS
ANTIBACTÉRIEN

page 64



Technique pour une communication toute en couleur



Impression
numérique à 360°

Toute en
couleur

Qualité
photographique

Haute définition

Couleurs illimitées
et améliorées

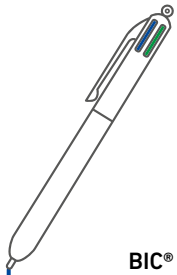

**BIC® Media
Clic - 1025**



page 40

**BIC® 4 Colours
1100 / 1101**



page 94

**BIC® 4 Colours
Fashion - 1102**



page 95

**BIC® 4 Colours
Sun - 1097**



page 95

**BIC® 4 Colours
Fine - 1109**



page 95

**BIC® Round
Stic® - 1010**



page 31

**BIC® Clic
Stic - 1000**



page 59

**BIC® Wide
Body™ - 1080**



page 84

**BIC® Wide Body™
chome - 1079**



page 84

BIC® Super Clip



page 77

**BIC® Evolution®
Ecolutions®**



page 142

INSTRUMENTS D'ÉCRITURE BIC®

STYLOS

BIC® Style	26
BIC® Round Stic®	30
BIC® Round Stic® Bguard™ antibacterial	34
BIC® M10® Clic	36
BIC® Media Clic	40
BIC® Media Clic Grip	44
BIC® Media Clic Bguard™ antibacterial	48
BIC® Media Clic Shine	50
BIC® Media Clic Bio	52
Ecolutions®	
BIC® Clic Stic	54
BIC® Clic Stic Bguard™ antibacterial	64
BIC® Clic Stic Stylus	66
Bguard™ antibacterial	
BIC® Super Clip	72
BIC® Super Clip Bguard™ antibacterial	74
BIC® Super Clip Advance	76
BIC® Wide Body™	82
BIC® Wide Body™	88
Bguard™ antibacterial	
BIC® Atlantis®	90
BIC® 4 Colours	96
BIC® 4 Colours Mini	98
BIC® 4 Colours Sun	99
BIC® 4 Colours Fashion	100
BIC® 4 Colours Shine	102
BIC® 4 Colours Glacé	104
BIC® 4 Colours Fine	106
BIC® 4 Colours Fluo	107
BIC® 4 Colours Stylus	108
BIC® 4 Colours 3+1	109

STYLOS MÉTALLIQUES

BIC® Metal Pro	112
----------------	-----

ROLLERS ET GELS

BIC® Grip Roller	118
BIC® XS Finestyle	120
BIC® Intensity® Gel Clic	112

SURLIGNEURS ET

MARQUEURS

BIC® Brite Liner® Grip	126
BIC® Velleda® White Board Marker Fine	130
BIC® Velleda® White Board Marker Grip	131
BIC® Mark-It Permanent Marker	132
BIC® Permanent Marker Ecolutions®	133

CRAYONS

BIC® Matic®	136
BIC® Evolution® Ecolutions®	141

Sprout

Sprout™	147
---------	-----



INSTRUMENTS D'ÉCRITURE

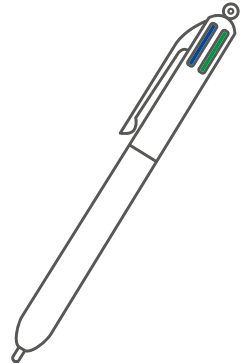

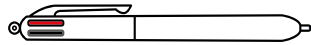

BIC® STYLE
1610 Opaque



01/01 01/03 01/05* 01/04 01/02 02/02

Couleur
d'encre



*Jusqu'à épuisement
du stock

100%



10 03 14 13 04

12



Commande minimale 500u.

Personnalisation :

1610 Clear



92

87

88

89

8H

93

BIC® STYLE

1610

A SP : max. 2 col.

BIC® STYLE CLEAR

1610

B SP : max. 1 col.

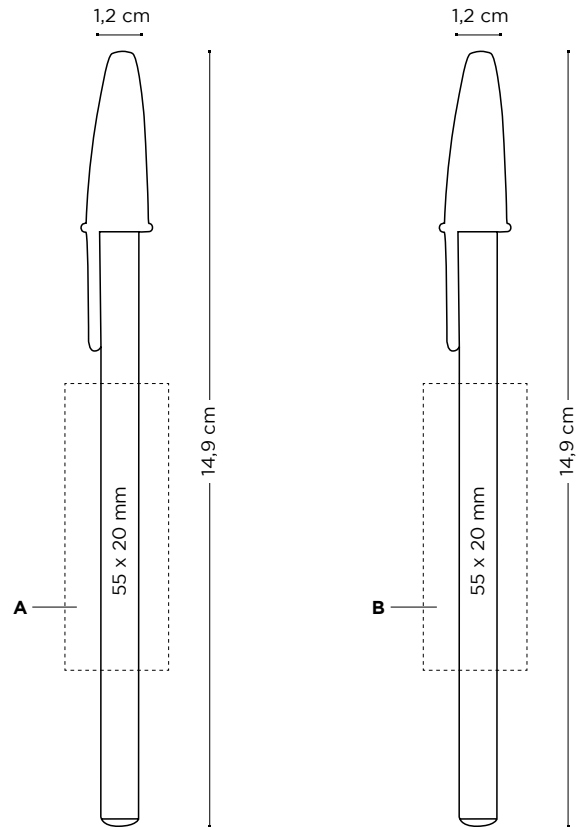

	Prix (€)		
BIC® STYLE / BIC® STYLE CLEAR	500-999	1000-2499	2500-4999
1610			5000
SP	0,44	0,40	0,38
			0,36

Frais d'impression supplémentaires par couleur et position

SP	0,13	0,13	0,13	0,12
-----------	------	------	------	------

Les prix incluent la sérigraphie 1 couleur sur une position.

Mode d'écriture :

Bille



M

Techniques d'impression :



(SP)
SÉRIGRAPHIE

Emballage spécial en option :



Plastic Pouch

+ INFO pag. 237

Emballage externe :



500 ± 3,5 Kg

www.bicgraphic.eu

27



ROUND STIC

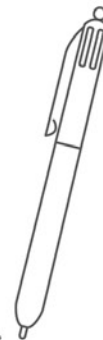

L'icône BIC® Round Stic® offre un style indémodable et une très grande qualité. Son design classique est facile à identifier et il est synonyme de fiabilité à long terme.

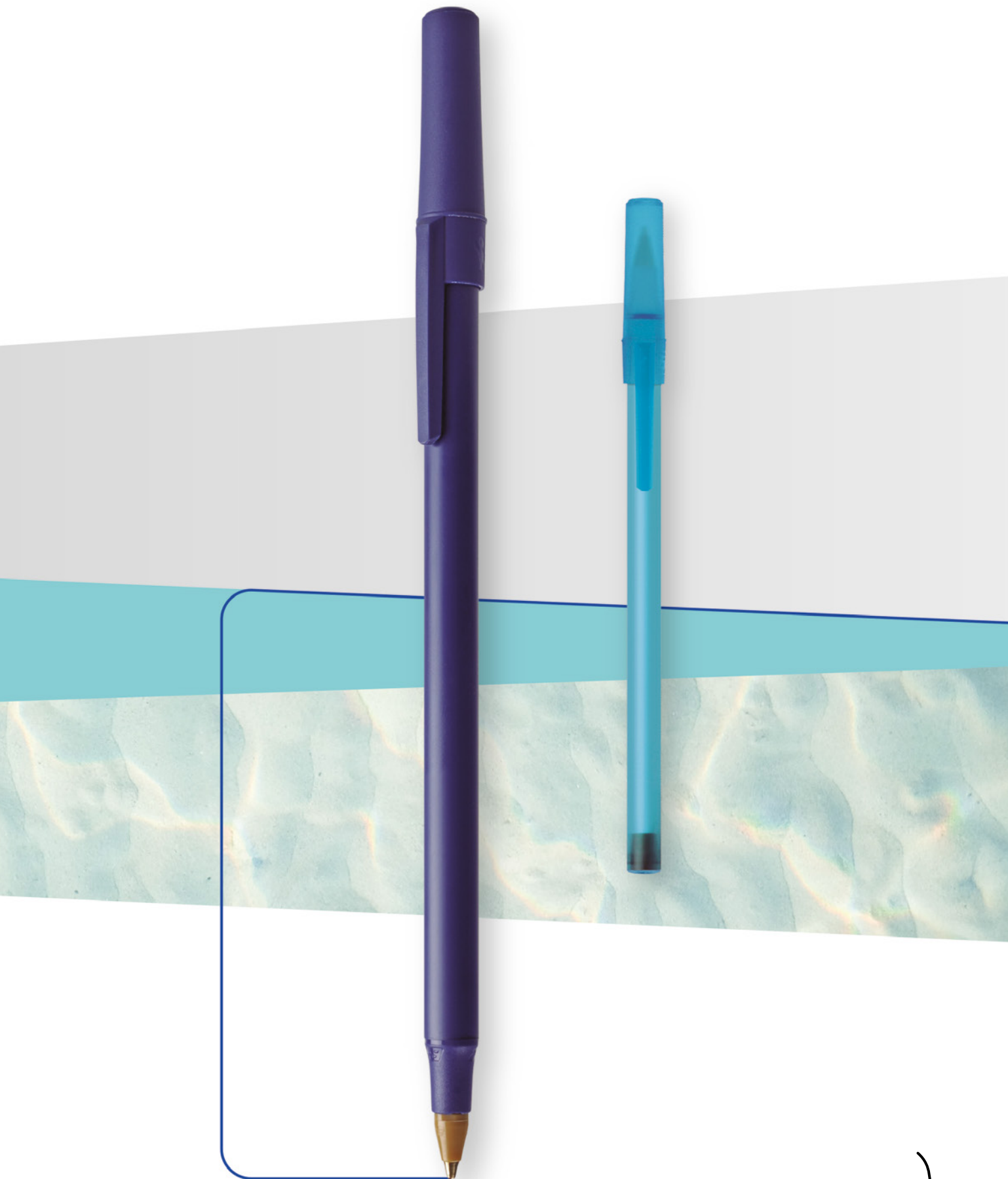

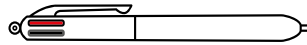

MIX & MATCH



1010 Opaque

1010 Givré



l'icône BIC® Boy est en relief



01

12

03

100%

05

07

18

02

69

63

71

66

68

100%

67

40

Couleur d'encre



Encre rouge disponible sur demande



**48h non disponible en impression numérique



ecolutions®



FABRIQUÉ À PARTIR DE 94%
DE MATÉRIEL* RECYCLÉ ET EST
100% RECYCLABLE

Fabriqué à partir de
cagettes plastiques
de fruits et légumes



La solution pour une
communication toute en couleur !

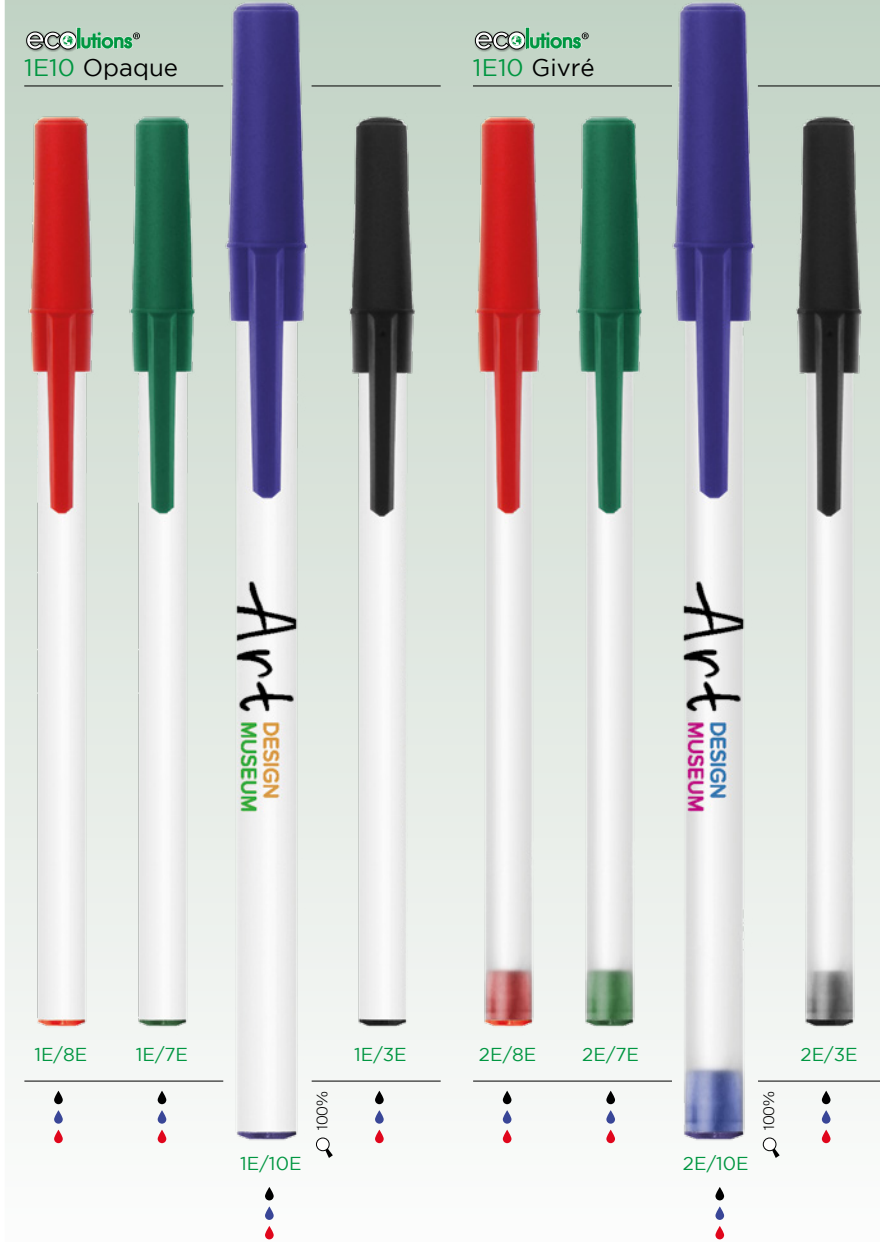

**Pourcentage calculé sur le poids total du produit cartouche exclue

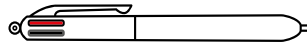

Commande minimale 500u.

Combinaison de couleurs standards

Combinaison de couleurs standards
eColutions®

Bouton

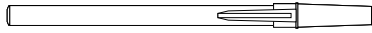

OPAQUE 01 12 10 03 05 20 04 07 18 02 GIVRÉ 69 63 71 66 68 67 40

Clip

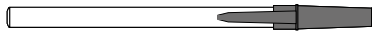

OPAQUE 01 12 10 03 05 20 04 07 18 02 GIVRÉ 69 63 71 66 68 67 40

Section

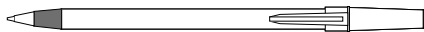

OPAQUE 01 12 10 03 05 20 04 07 18 02 GIVRÉ 69 63 71 66 68 67 40

Corps



OPAQUE 01 12 03 05 07 18 02 GIVRÉ 69 63 71 66 68 67 40

8E 7E 10E 3E

8E 7E 10E 3E

8E 7E 10E 3E

OPAQUE 1E GIVRÉ 2E

Injection d'une couleur spéciale :

≥ 10.000 unités



Ajoutez la boucle mobius sur votre BAT sans frais additionnels. Merci de le préciser dans votre bon de commande (en bas à gauche par défaut)



Mode d'écriture :

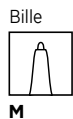

M

Techniques d'impression :



(SP) SÉRIGRAPHIE



(DG) NUMÉRIQUE



Emballage spécial en option :



Plastic Pouch

+ INFO pag. 237

Emballage externe :



500 ± 2,5 Kg



FABRIQUÉ EN ESPAGNE

Personnalisation :

BIC® ROUND STIC®

1010

©©olutions® 1E10

A SP : max. 3 col.

B SP : max. 1 col.

C DG : Numérique (uniquement disponible en corps blanc)

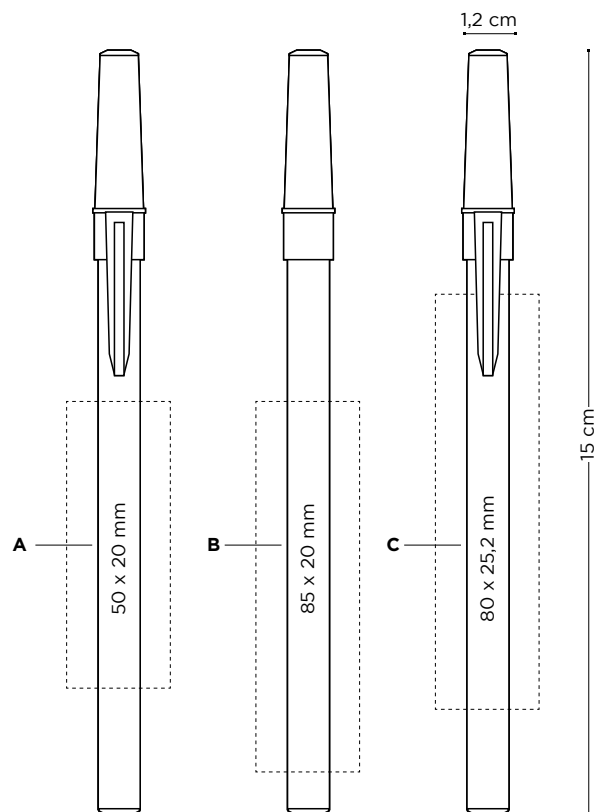

				Prix (€)
BIC® ROUND STIC®	500-999	1000-2499	2500-4999	5000
1010 / ©©olutions® 1E10				
SP	0,46	0,44	0,42	0,39
DG	0,63	0,60	0,57	0,53

Frais d'impression supplémentaires par couleur et position

SP	0,13	0,13	0,13	0,12
-----------	------	------	------	------

Les prix incluent une impression sur une position avec la technique indiquée.

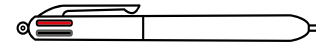

Le Bonhomme BIC® iconique et le logo antibactérien toujours visibles!

1011
Opaque



01

Couleur d'encre



Encre rouge disponible sur demande



03



07



02



1011
Opaque



01



Commande minimale 500u.

Combinaison de couleurs standards

Bouton

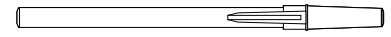

OPAQUE



Clip

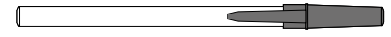

OPAQUE



Section

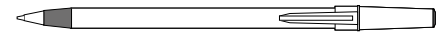

OPAQUE



Corps



OPAQUE



Injection d'une couleur spéciale :

≥ 10.000 unités

Uniquement disponible en corps blanc

**48h non disponible en impression numérique

Disponible dans certains pays uniquement. Veuillez contacter votre attaché de clientèle pour plus d'information

Personnalisation :

BIC® ROUND STIC® BGUARD™ ANTIBACTERIAL

1011

A SP : max. 2 col.

B DG : Numérique

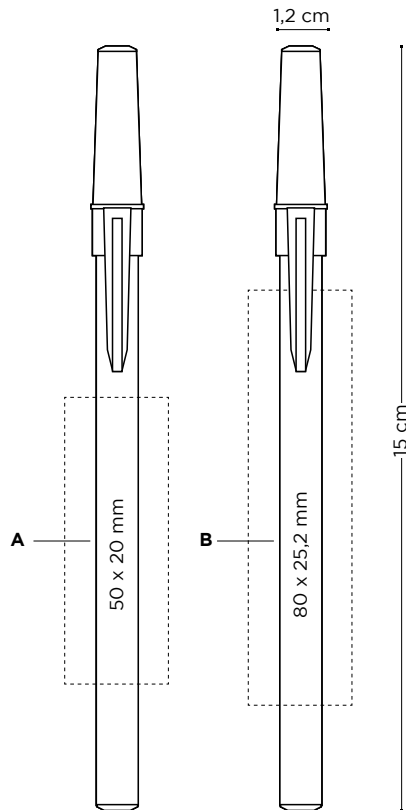

	Prix (€)			
BIC® ROUND STIC® BGUARD™ ANTIBACTERIAL	500-999	1000-2499	2500-4999	5000
1011				
SP	0,48	0,46	0,44	0,41
DG	0,66	0,63	0,60	0,56

Frais d'impression supplémentaires par couleur et position

SP	0,13	0,13	0,13	0,12
-----------	------	------	------	------

Les prix incluent une impression sur une position avec la technique indiquée.

Mode d'écriture :

Bille



M

Techniques d'impression :



(SP)
SÉRIGRAPHIE



(DG)
NUMÉRIQUE



Emballage spécial en option :



Plastic Pouch

+ INFO pag. 237

Emballage externe :



500 ± 2,5 Kg



FABRIQUÉ
EN ESPAGNE

www.bicgraphic.eu

35

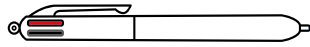

BIC® M10® CLIC
1590

L'icône
BIC® Boy
est en relief

Bouton-poussoir
latéral



Commande minimale 500u.

Personnalisation :

BIC® M10® CLIC

1590

A SP : max. 2 col.

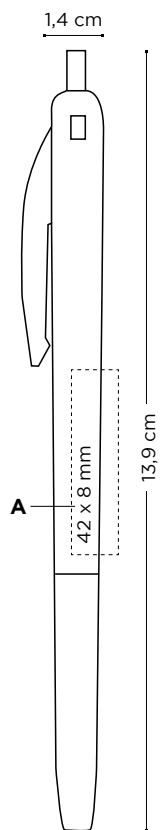

	Prix (€)			
BIC® M10® CLIC	500-999	1000-2499	2500-4999	5000
1590				
SP	0,53	0,51	0,48	0,45
Frais d'impression supplémentaires par couleur et position				
SP	0,13	0,13	0,13	0,12

Les prix incluent la sérigraphie 1 couleur sur une position.

Mode d'écriture :

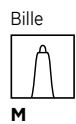

Techniques d'impression :



Emballage spécial en option :



Emballage externe :



Regardez la video





MEDIA CLIC

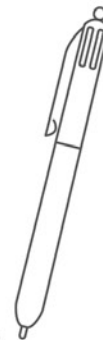

Un des best-seller du secteur, fonctionnel et au design déjà reconnu, notre BIC® Media Clic est un produit durable disponible en différents matériaux, à choisir entre les versions Standard, Recyclée, BIO et Antibactérienne. Laissez-vous inspirer par la large gamme de finitions et de couleurs en les utilisant comme complément pour renforcer votre marque. On célèbre ses 20 ans cette année.



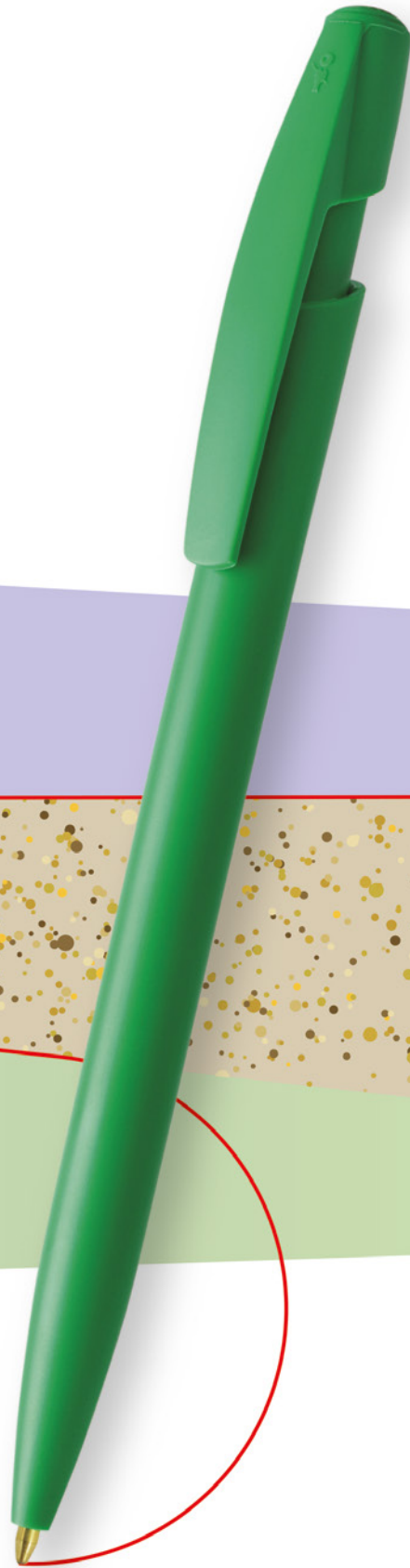

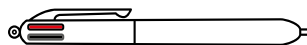

La solution pour
une communication toute **en couleur**



MIX & MATCH



Maintenant sur des corps en couleur

Brillant
1025 Bille

Opaque
1025 / 1E25 Bille
1028 / 1E28 Crayon

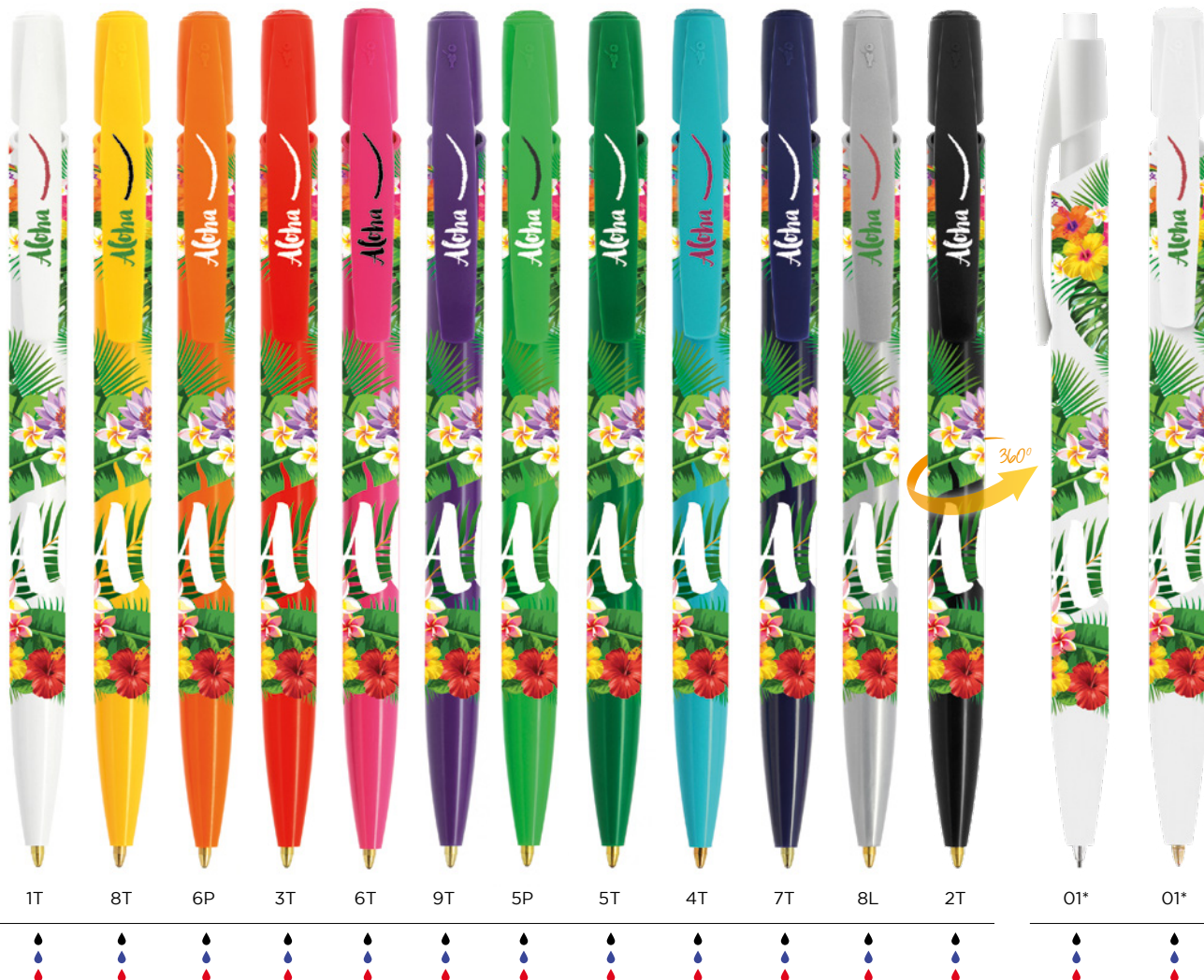

1T 8T 6P 3T 6T 9T 5P 5T 4T 7T 8L 2T 01* 01*



Couleur d'encre

Encre rouge disponible sur demande

*Uniquement disponible en corps blanc

**48h non disponible en impression numérique



Transparent
1025 Bille



Plus de 10 000
clics !

*Jusqu'à épuisement du stock



www.bicgraphic.eu

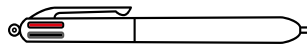

MIX & MATCH



Opaque
1025 Bille
1028 Porte-mines



Couleur d'encre

Encre rouge disponible sur demande

**48h non disponible en impression numérique



Givré
1025 Bille
1028 Porte-mines

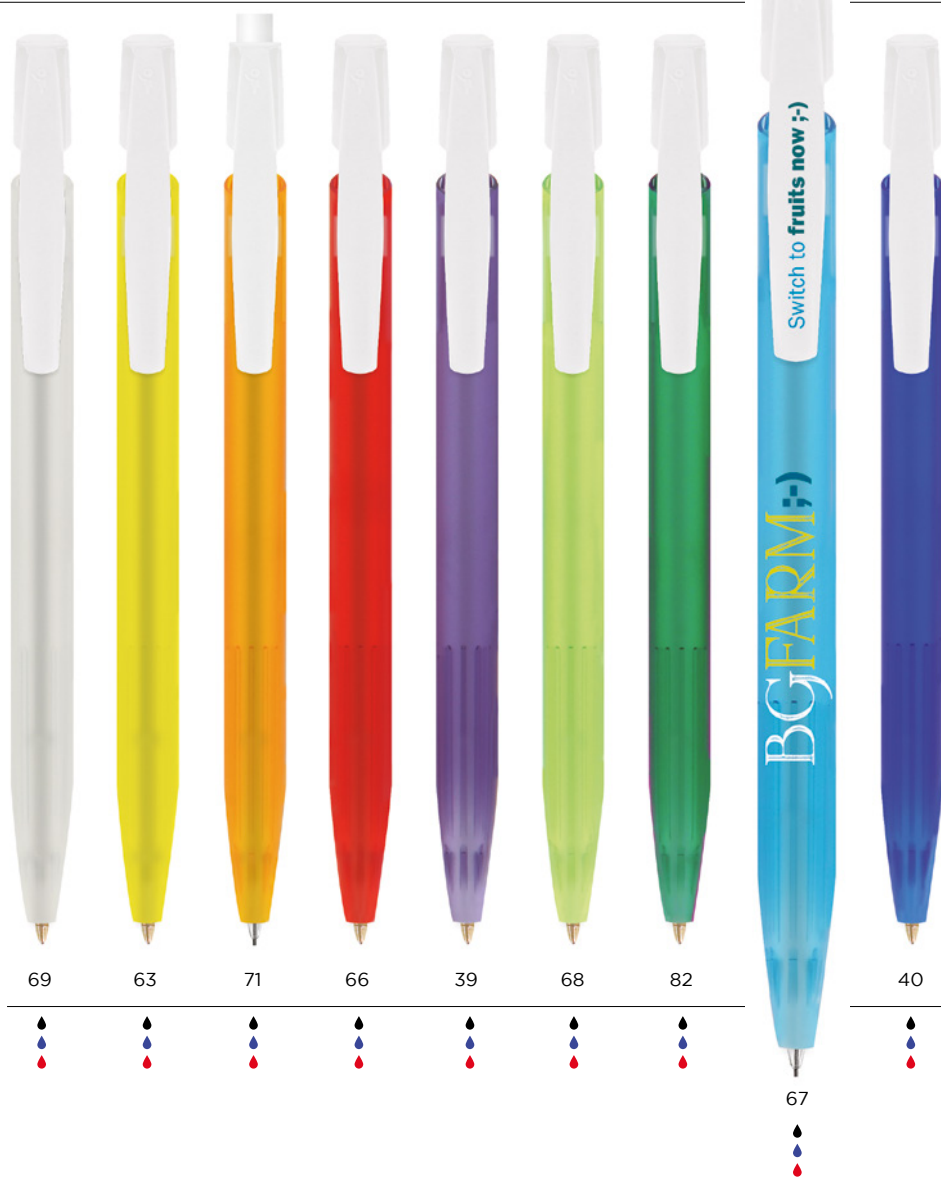



MEDIA CLIC GRIP

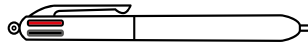

MIX & MATCH



britePix DIGITAL

Opaque
1020 Bille
1021 Porte-mines



01/05

01/12

Uniquement disponible en corps blanc

Opaque
1020 Bille
1021 Porte-mines



01/12*

01/03*

01/05*

Couleur d'encre

*Jusqu'à épuisement du stock

Encre rouge disponible sur demande

Givré
1020 Bille
1021 Porte-mines



01/07*

01/02*

01/69

69/69*

71/69*

66/69

82/69

40/69

*Jusqu'à épuisement du stock



**48h non disponible en impression numérique

ecolutions®



FABRIQUÉ À PARTIR DE 92%
DE MATÉRIEL* RECYCLÉ ET
100% RECYCLABLE



FABRIQUÉ À PARTIR DE 50%
DE MATÉRIEL* RECYCLÉ ET
100% RECYCLABLE



ecolutions®
Opaque
1E25
Bille



1E

ecolutions®
Opaque
1E20 Bille
1E21 Porte-mines



01/12*

01/03

01/05

01/07

01/02

*Jusqu'à épuisement du stock

*Pourcentage calculé sur le poids total du corps du stylo

Regardez la video



www.bicgraphic.eu

45



MEDIA CLIC

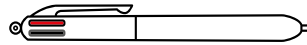

Commande minimale 500u.

Combinaison de couleurs standards Combinaison de couleurs standards

Bouton



OPAQUE 01 12 10 03 5C 2D 13 84* 5G 05 3D 04 07 18 02 GIVRÉ 69

Clip



OPAQUE 01 12 10 03 5C 2D 13 84* 5G 05 3D 04 07 18 02 GIVRÉ 69

Corps



OPAQUE 01 12 10 03 5C 2D 13 5G 05 3D 04 07 3C 18 02 01/12* 01/03* 01/05* 01/07* 01/02* *Jusqu'à épuisement du stock

Corps et Grip

GIVRÉ 69 63 71 66 39 68 82 67 40 01/69 69/69* 71/69* 66/69 82/69 40/69

Corps et Grip

BRILLANT 1T 8T 6P 3T 6T 9T 5P 5T 4T 7T 8L 2T



Toute la gamme de couleurs est disponible en Digital BritePix™

TRANSPARENT 1R* 4D* 92* 87* 95* 93* 88* 72* 4R* 7R* 91*



Ajoutez la boucle mobius sur votre BAT sans frais additionnels. Merci de le préciser dans votre bon de commande (en bas à gauche par défaut)



OPAQUE 1E
Corps et Grip OPAQUE
01/12* 01/03 01/05 01/07 01/02
*Jusqu'à épuisement du stock

Instruments d'écriture Bic • STYLOS

Injection d'une couleur spéciale :

≥ 10.000 unités 1025/1028 1E25 1E20/1E21

Mode d'écriture :

Bille M
Porte-mine MP Ø0,7mm

Techniques d'impression :

(SP) SÉRIGRAPHIE
(DG) NUMÉRIQUE

*Jusqu'à épuisement du stock



Personnalisation :

BIC® MEDIA CLIC

- 1025 (bille)
- 1028 (porte-mines)
- ©©olutions® 1E25 (bille)
- A SP** : max. 4 col.
- B SP** : max. 2 col.
- C DG** : Numérique

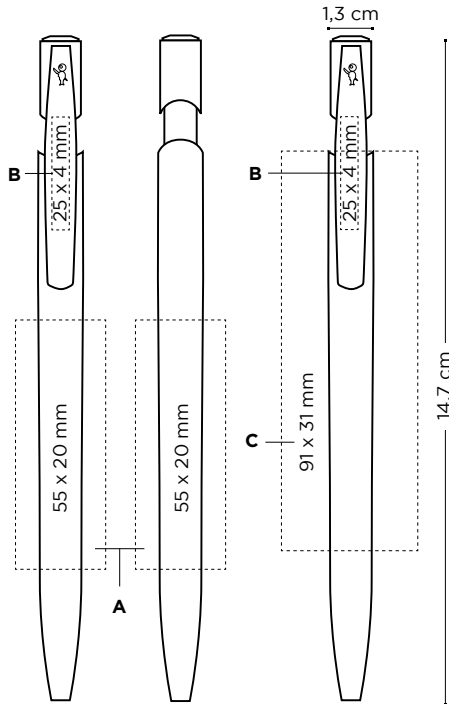

BIC® MEDIA CLIC GRIP

- 1020 (bille)
- 1021 (porte-mines)
- D SP** : max. 4 col.
- E SP** : max. 2 col.
- F DG** : Numérique
- ©©olutions® 1E20 (bille)
- ©©olutions® 1E21 (porte-mines)
- D SP** : max. 4 col.
- E SP** : max. 2 col.

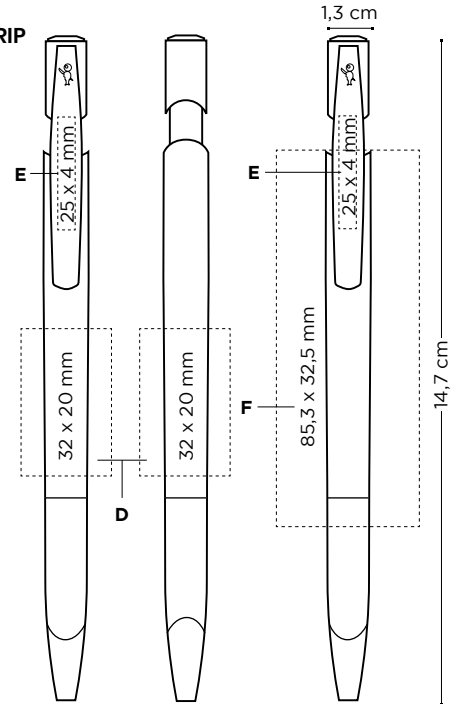

	Prix (€)			
BIC® MEDIA CLIC	500-999	1000-2499	2500-4999	5000
1025 / ©©olutions® 1E25 (bille)				
SP	0,60	0,56	0,52	0,48
DG	0,82	0,77	0,71	0,67
1028 (crayon)				
SP	0,78	0,73	0,68	0,64
DG	0,92	0,86	0,80	0,76

Frais d'impression supplémentaires par couleur et position

SP	0,13	0,13	0,13	0,12
-----------	------	------	------	------

Les prix incluent une impression sur une position avec la technique indiquée.

	Prix (€)			
BIC® MEDIA CLIC GRIP	500-999	1000-2499	2500-4999	5000
1020 / ©©olutions® 1E20 (bille)				
SP	0,90	0,84	0,79	0,73
1020 (bille)				
DG	1,12	1,05	0,98	0,92
1021 / ©©olutions® 1E21 (crayon)				
SP	1,00	0,93	0,87	0,82
1021 (crayon)				
DG	1,22	1,14	1,06	1,01

Frais d'impression supplémentaires par couleur et position

SP	0,13	0,13	0,13	0,12
-----------	------	------	------	------

Les prix incluent une impression sur une position avec la technique indiquée.

Emballage externe :



500 ± 4,1 Kg

Emballage spécial en option :



ECO Sleeve / Plastic Pouch / Window Box

+ INFO pag. 236 & 237

Emballage externe :



500 ± 4,3 Kg

Regardez la video



www.bicgraphic.eu

47



MEDIA CLIC B_GUARD™ ANTIBACTERIAL

NOUVEAU

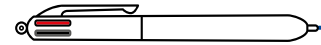

PROTECTION ANTI-BACTÉRIENNE



PROTECTION SUR TOUTE LA SURFACE DU STYLO



PROTECTION À VIE



TESTÉ PAR UN PROTOCOLE ANTIBACTÉRIEN



MIX & MATCH



1026 Opaque



01



03



07



02

1026 Opaque

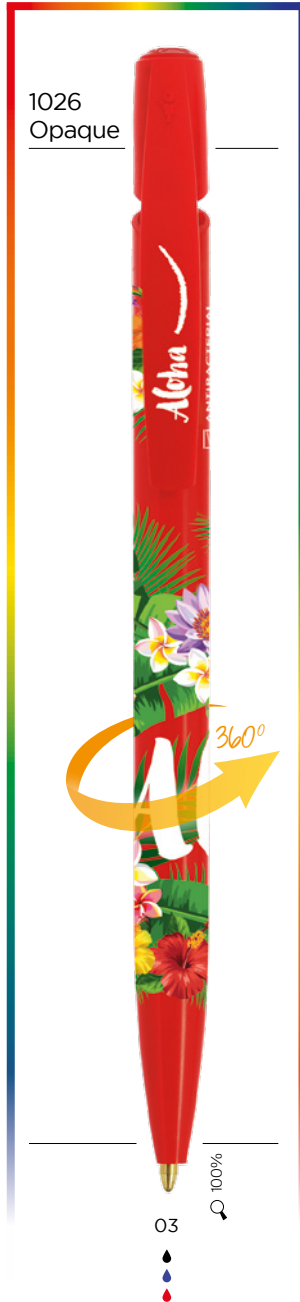

03

Le Bonhomme BIC® iconique et le logo antibactérien toujours visibles!

Commande minimale 500u.

Combinaison de couleurs standards

Bouton

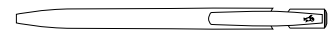

OPAQUE 01 03 07 02

Clip



OPAQUE 01 03 07 02

Corps



OPAQUE 1T 3T 7T 2T

Injection d'une couleur spéciale :

≥ 10.000 unités

**48h non disponible en impression numérique. Disponible dans certains pays uniquement. Veuillez contacter votre attaché de clientèle pour plus d'information

Personnalisation :

BIC® MEDIA CLIC BGuard™ ANTIBACTERIAL

1026

A SP : max. 3 col.

B SP : max. 1 col.

C DG : Numérique

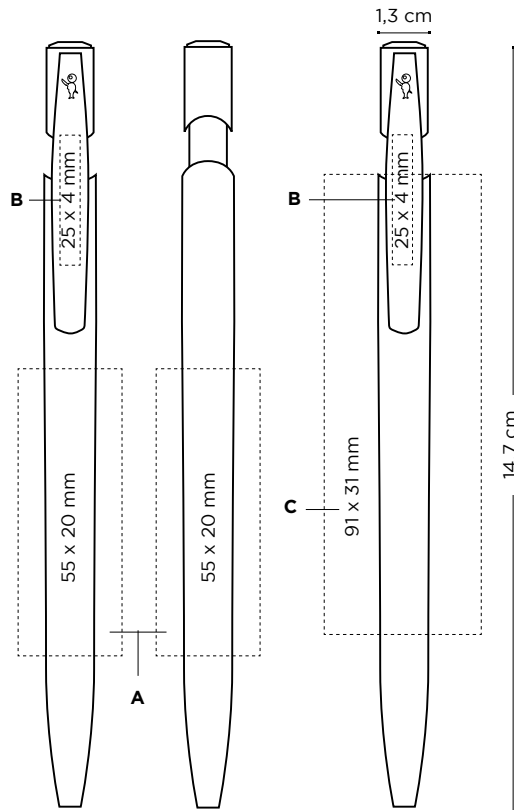

	Prix (€)			
BIC® MEDIA CLIC BGuard™ ANTIBACTERIAL	500-999	1000-2499	2500-4999	5000
1026				
SP	0,63	0,59	0,55	0,50
DG	0,86	0,81	0,75	0,70

Frais d'impression supplémentaires par couleur et position

SP	0,13	0,13	0,13	0,12
-----------	------	------	------	------

Les prix incluent une impression sur une position avec la technique indiquée.

Mode d'écriture :



M

Techniques d'impression :



(SP)
SÉRIGRAPHIE



(DG)
NUMÉRIQUE



Emballage spécial en option :



ECO Sleeve / Plastic Pouch / Window Box

+ INFO pag. 236 & 237

Emballage externe :



500 ± 4,1 Kg



FABRIQUÉ
EN ESPAGNE

www.bicgraphic.eu



MEDIA CLIC SHINE

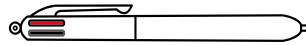

1975 Opaque Bille



01/75



01/26

Couleur d'encre

Encre rouge disponible sur demande



MIX & MATCH



BIC® MEDIA CLIC SHINE

1975

A SP : max. 2 col.

B SP : max. 2 col.

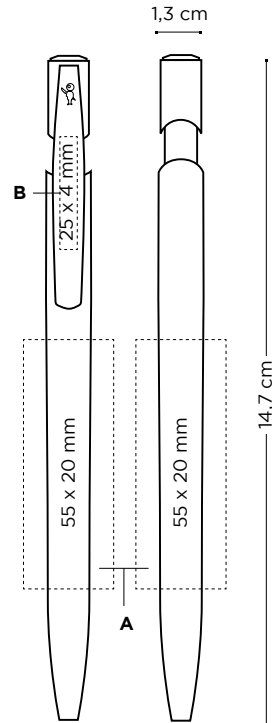

Prix (€)

BIC® MEDIA CLIC SHINE	500-999	1000-2499	2500-4999	5000
1975				
SP	1,22	1,14	1,06	0,98
SP (premium)	1,36	1,27	1,18	1,09

Frais d'impression supplémentaires par couleur et position

SP	0,13	0,13	0,13	0,12
----	------	------	------	------

Les prix incluent la sérigraphie 1 couleur sur un emplacement.

Commande minimale 500u.

Combinaison de couleurs standards

Bouton

OPAQUE 01 12 10 03 5C 2D 13 84 5G 05 3D 04 07 18 02 GIVRÉ 69 PREMIUM 35*

Clip



OPAQUE 01 12 10 03 5C 2D 13 84* 5G 05 3D 04 07 18 02 GIVRÉ 69

Corps

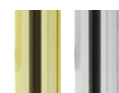

SHINE 01/26 01/75

Mode d'écriture :



M

*Jusqu'à épuisement du stock

Techniques d'impression :



(SP) SÉRIGRAPHIE

Emballage spécial en option :



ECO Sleeve / Plastic Pouch / Window Box

Emballage externe :

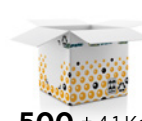

500 ± 4,1 Kg



FABRIQUÉ EN ESPAGNE



LA PREMIÈRE PRIORITÉ DE POUR LE CYCLE DE VIE DU MEDIA CLIC BIO ECOLUTIONS® EST LA VIABILITE ECOLOGIQUE

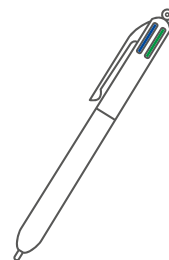

STYLO BIODÉGRADABLE :

Le corps est **100% biodégradable** et le clip est **100% recyclable**.

MATERIEL BIO :

Le corps est fabriqué à partir de **70% de matériel bio**. Les colorants sont 100% bio.

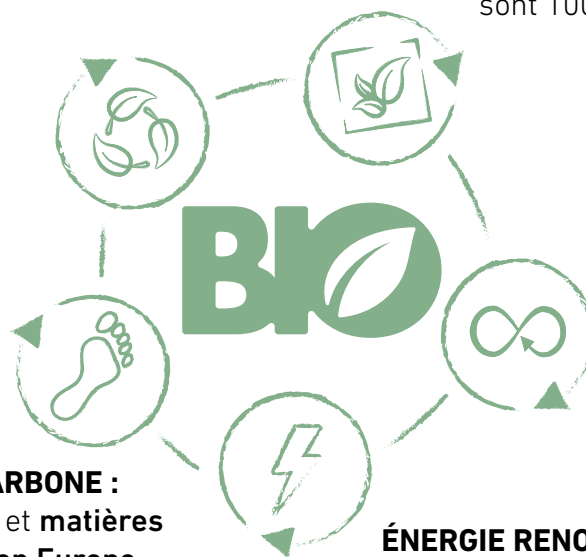

FAIBLE EMPREINTE CARBONE :

Production, impression et **matières premières fabriquées en Europe**.

FAIT POUR DURER :

- Plus de **10,000 clics**
- Clip incassable

ÉNERGIE RENOUVELABLE :

Notre usine est alimentée à **100% par de l'électricité renouvelable**.

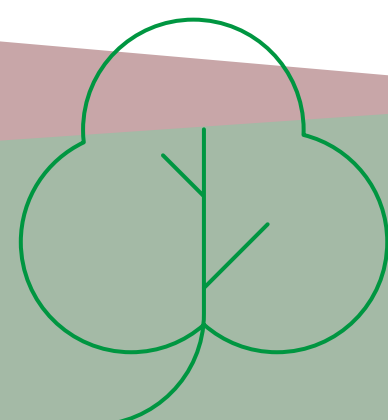

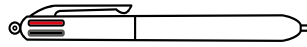

FABRIQUÉ À PARTIR DE 70% DE MATÉRIEL* BIO ET EST **100% BIODÉGRADABLE**



1972 Opaque Bille



Toujours visible!

Couleur d'encre

Encre rouge disponible sur demande

*Pourcentage calculé sur le poids total du corps du stylo, biodegradable under industrial conditions



*Uniquement disponible en corps blanc

**48h non disponible en impression numérique

Commande minimale 500u.

Combinaison de couleurs standards

Bouton

OPAQUE 01 12 10 03 5C 2D 13 84* 5G 05 3D 04 07 18 02 GIVRÉ 69

Clip

OPAQUE 01 12 10 03 5C 2D 13 84* 5G 05 3D 04 07 18 02 GIVRÉ 69

Corps

OPAQUE 01BIO 012BIO 03BIO 05BIO 04BIO 02BIO

BIC® MEDIA CLIC BIO

ecoSolutions®

1972

A SP : max. 4 col.

B SP : max. 2 col.

C DG : Numérique

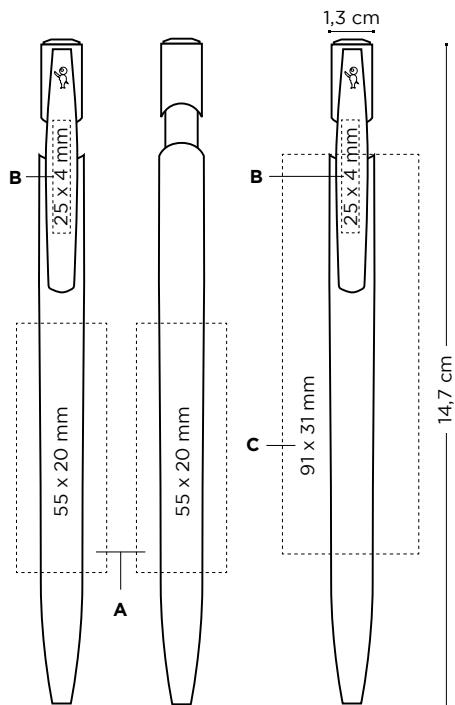

BIC® MEDIA CLIC BIO ecoSolutions®	500-999	1000-2499	2500-4999	5000
1972				
SP	0,76	0,71	0,66	0,61
DG	0,98	0,92	0,85	0,80

Frais d'impression supplémentaires par couleur et position

SP	0,13	0,13	0,13	0,12
----	------	------	------	------

Les prix incluent la sérigraphie 1 couleur sur une position.

Mode d'écriture :



M

*Jusqu'à épuisement du stock

Techniques d'impression :



(SP) SÉRIGRAPHIE



(DG) NUMÉRIQUE



Emballage spécial en option :



ECO Sleeve / Plastic Pouch / Window Box

+ INFO pag. 236 & 237

Emballage externe :



500 ± 4,3 Kg



FABRIQUÉ EN ESPAGNE



www.bicgraphic.eu

53



CLIC STIC

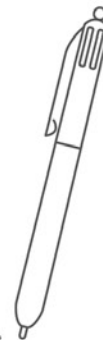

Moderne, souple, fiable. C'est comme ça que le BIC® Clic Stic est !
Une grande variété de finitions telles que Digital, Stylus, Softfeel®, Mini ou Antibactérien, et des milliers de combinaisons de couleurs !

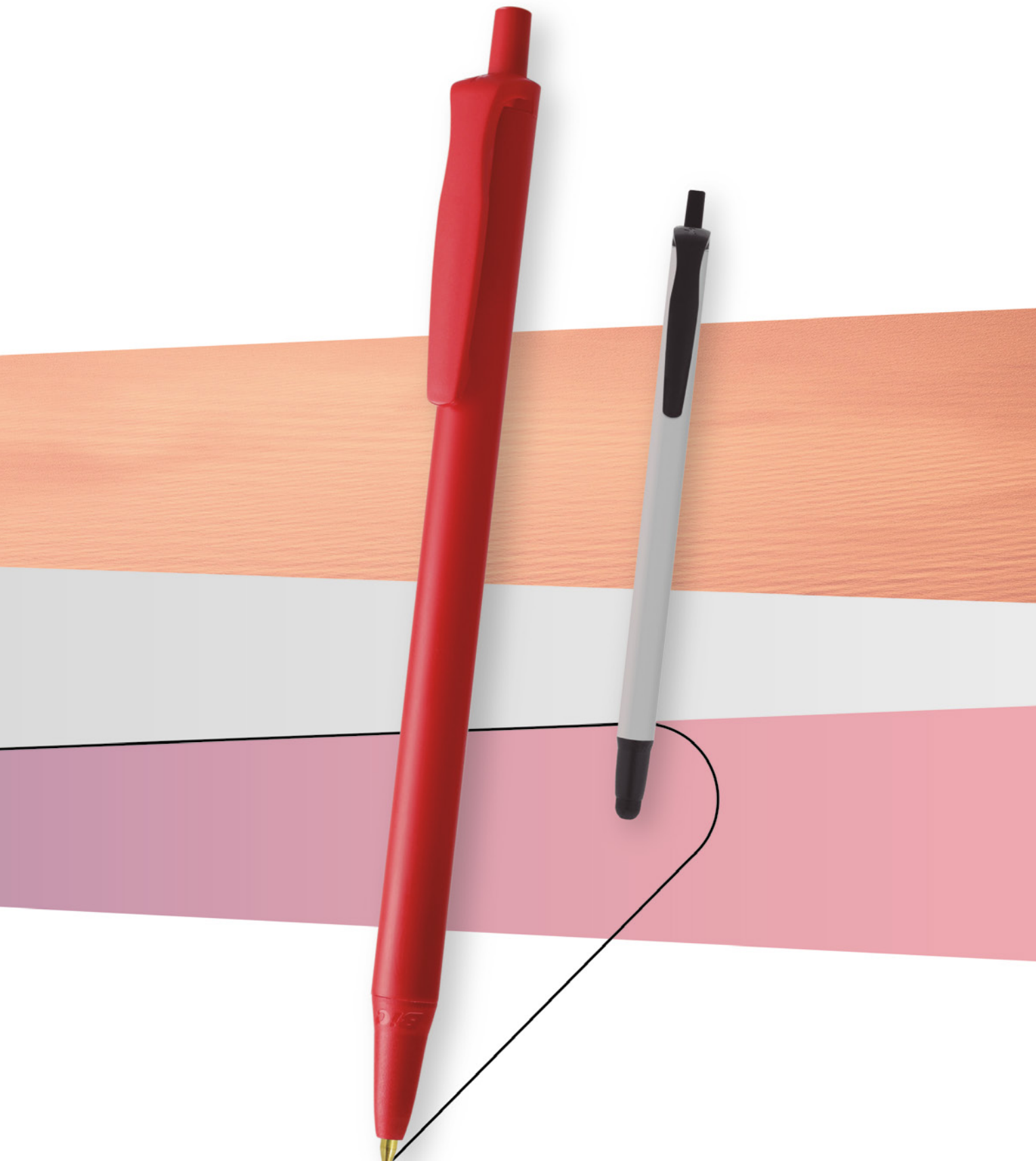

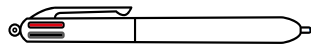

MIX & MATCH



l'icône BIC® Boy est en relief

clip résistant incassable !

1000 Opaque

1000 Givré



01

12

03

05

04

07

18

02

69

63

71

66

68

67

40

Couleur d'encre

Encre rouge disponible sur demande



**48h non disponible en impression numérique



ecolutions®



FABRIQUÉ À PARTIR DE 78%
DE MATÉRIEL* RECYCLÉ ET
100% RECYCLABLE

Fabriqué à partir de
cagettes plastiques
de fruits et légumes



ecolutions®
1E00
Opaque



1E/8E

1E/7E



100%
1E/10E



1E/3E

ecolutions®
1E00
Givré



2E/8E



100%
2E/7E



2E/10E



2E/3E

BIC® CLIC STIC STYLUS
ecolutions®
1846
Opaque



1E



100%
3E



*Pourcentage calculé sur le poids total du corps du stylo

BIC® CLIC STIC STYLUS ECOLUTIONS®.

60% de matériaux recyclés calculés sur le poids total des pièces en plastique (à l'exception des cartouches et des ressorts)



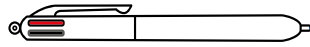

MIX & MATCH



**BIC® CLIC STIC
SOFTFEEL®
1005 Opaque**

1005 Givré

**BIC® CLIC STIC STYLUS
1847 Opaque**



20



07



02



40



01



03



04



07



18



02

Couleur d'encre



Encre rouge disponible sur demande

*48h non disponible en impression numérique





La solution pour une **communication toute en couleur !**

BIC® CLIC STIC MINI
1892 Opaque



BIC® CLIC STIC DIGITAL
1000 / 1E00
Opaque

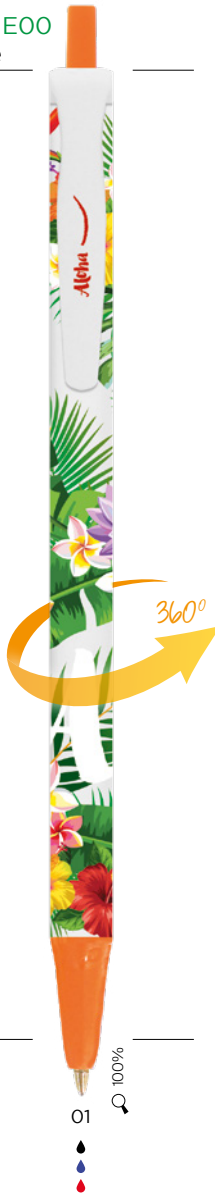

BIC® CLIC STIC STYLUS DIGITAL
1847
Opaque



BIC® CLIC STIC MINI DIGITAL
1892
Opaque



Uniquement disponible en corps blanc

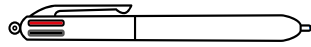

Commande minimale 500u.

Combinaison de couleurs standards

Bouton

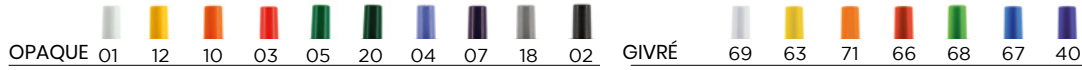

Clip

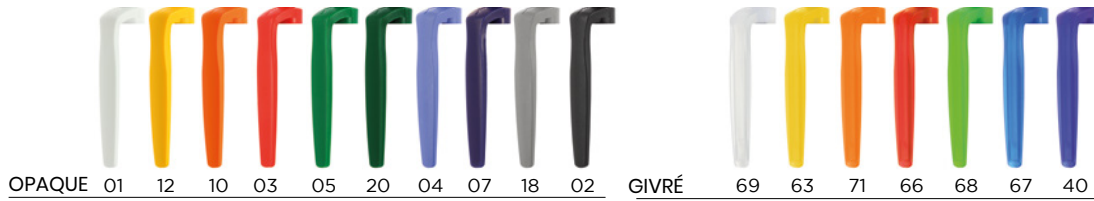
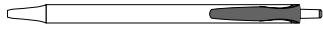

Section

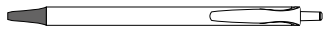

stylus

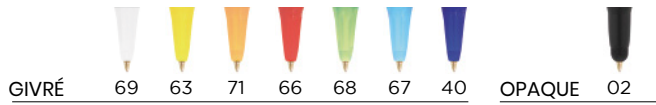

Corps

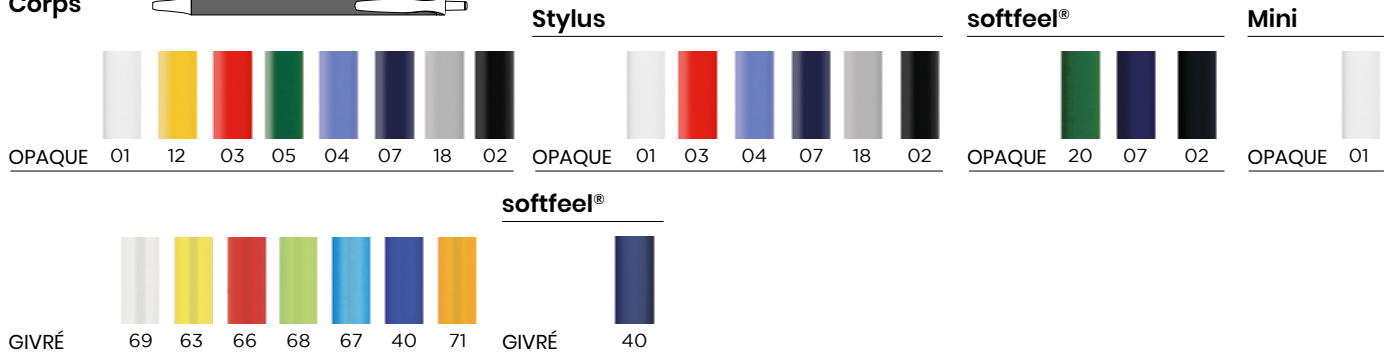

Injection d'une couleur spéciale :

≥ 10.000 unités

Mode d'écriture :

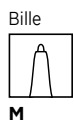









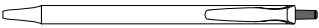

Techniques d'impression :











Commande minimale 500u.





Combinaison de couleurs standards **ecolutions®**

Bouton 





										
OPAQUE	01	12	10	03	05	20	04	07	18	02

							
GIVRÉ	69	63	71	66	68	67	40

Clip 





				
OPAQUE	8E	7E	10E	3E

Section 

				
OPAQUE	8E	7E	10E	3E

Corps 

Stylus

		Givré		OPAQUE		
OPAQUE	1E		2E	OPAQUE	1E	3E



Ajoutez la boucle mobius sur votre BAT sans frais additionnels. Merci de le préciser dans votre bon de commande (en bas à gauche par défaut)

Injection d'une couleur spéciale :

≥ 10.000 unités

Mode d'écriture : **Techniques d'impression :**



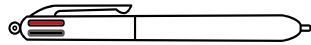

Personnalisation :

BIC® CLIC STIC

1000
 @COlutions® 1E00

BIC® CLIC STIC STYLUS

1847
 @COlutions® 1846

- A SP :** max. 3 col.
- B SP :** max. 1 col.
- C SP :** max. 2 col.
- D DG :** Numérique (zone texte)
(uniquement disponible en corps blanc)
- E DG :** Numérique (zone image)
(uniquement disponible en corps blanc)

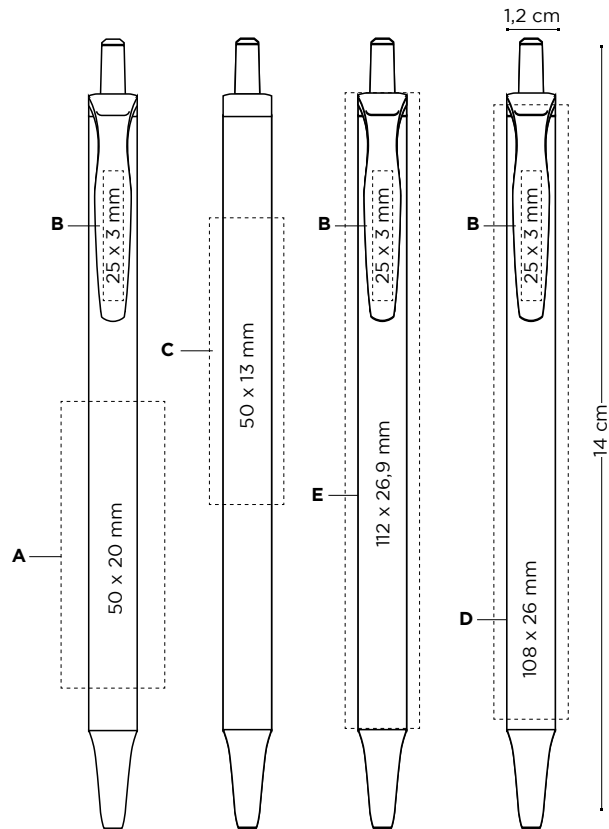

	Prix (€)			
BIC® CLIC STIC	500-999	1000-2499	2500-4999	5000
1000 / @COlutions® 1E00				
SP	0,77	0,71	0,67	0,63
DG	1,02	0,95	0,89	0,84
1847 / @COlutions® 1846				
SP	0,92	0,86	0,81	0,74
DG	1,16	1,08	1,01	0,95

Frais d'impression supplémentaires par couleur et position

SP	0,13	0,13	0,13	0,12
-----------	------	------	------	------

Les prix incluent une impression sur une position avec la technique indiquée.

Emballage spécial en option :



ECO Sleeve / Plastic Pouch

Emballage externe :



500 ± 2,9 Kg



FABRIQUÉ EN ESPAGNE

BIC® CLIC STIC SOFTFEEL®

1005

A/B SP : max. 1 col.

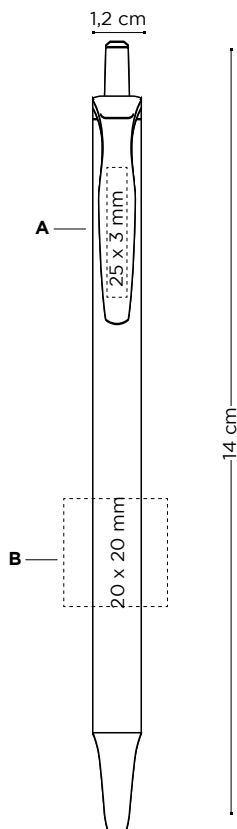

BIC® CLIC STIC MINI

1892

A SP : max. 1 col.

B SP : max. 1 col.

C DG : Numérique (zone texte)
(uniquement disponible en corps blanc)

D DG : Numérique (zone image)
(uniquement disponible en corps blanc)

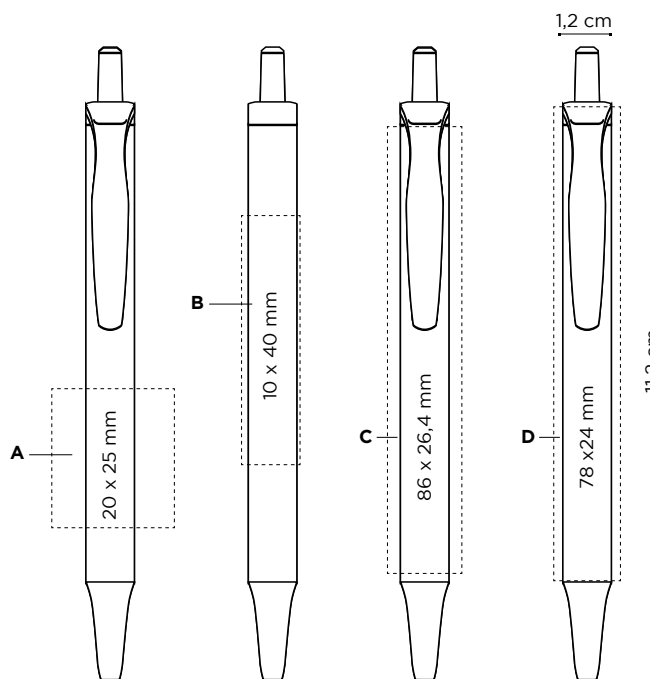

	Prix (€)			
BIC® CLIC STIC SOFTFEEL®	500-999	1000-2499	2500-4999	5000
1005				
SP	0,90	0,84	0,79	0,72

Frais d'impression supplémentaires par couleur et position

SP	0,13	0,13	0,13	0,12
-----------	------	------	------	------

Les prix incluent la sérigraphie 1 couleur sur une position.

	Prix (€)			
BIC® CLIC STIC MINI DIGITAL	500-999	1000-2499	2500-4999	5000
1892				
SP	0,65	0,61	0,57	0,54
DG	0,94	0,88	0,82	0,77

Les prix incluent une impression sur une position avec la technique indiquée.

Emballage spécial en option :



ECO Sleeve / Plastic Pouch

+ INFO pag. 236 & 237

Emballage externe :



500 ± 2,9 Kg

Emballage externe :



500 ± 2,4 Kg



CLIC STIC B^GUARD™ ANTIBACTERIAL

NOUVEAU

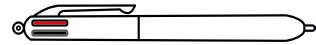

PROTECTION ANTI-BACTÉRIENNE



PROTECTION SUR TOUTE LA SURFACE DU STYLO



PROTECTION À VIE



TESTÉ PAR UN PROTOCOLE ANTIBACTÉRIEN



MIX & MATCH



1001 Opaque



01

Couleur d'encre



Encre rouge disponible sur demande



03



07



02

1001 Opaque



01

Uniquement disponible en corps blanc

Le Bonhomme BIC® iconique et le logo antibactérien toujours visibles !

Commande minimale 500u.

Combinaison de couleurs standards

Bouton

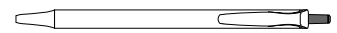

OPAQUE



Clip



OPAQUE



Section

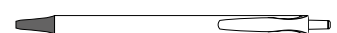

OPAQUE



Corps



OPAQUE



Injection d'une couleur spéciale :

≥ 10.000 unités

**48h non disponible en impression numérique

Disponible dans certains pays uniquement. Veuillez contacter votre attaché de clientèle pour plus d'information

Personnalisation :

BIC® CLIC STIC BGUARD™ ANTIBACTERIAL

1001

A SP : max. 2 col.

B SP : max. 1 col.

C DG : Numérique

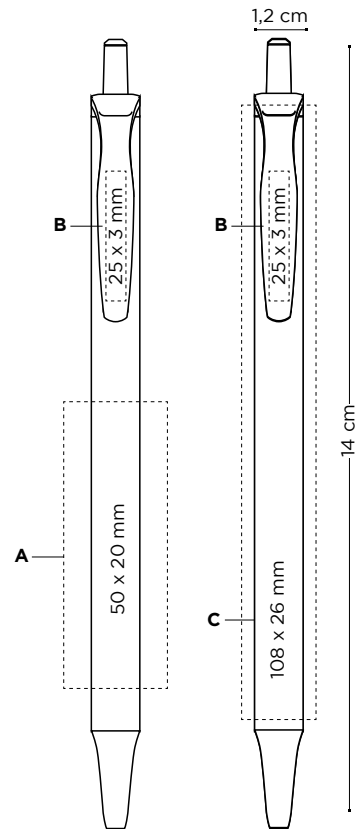

	Prix (€)			
BIC® CLIC STIC BGUARD™ ANTIBACTERIAL	500-999	1000-2499	2500-4999	5000
1001				
SP	0,81	0,75	0,70	0,66
DG	1,07	1,00	0,93	0,88

Frais d'impression supplémentaires par couleur et position

SP	0,13	0,13	0,13	0,12
-----------	------	------	------	------

Les prix incluent une impression sur une position avec la technique indiquée.

Mode d'écriture :

Bille



M

Techniques d'impression :



(SP)
SÉRIGRAPHIE



(DG)
NUMÉRIQUE



Emballage spécial en option :



ECO Sleeve / Plastic Pouch

+ INFO pag. 236 & 237

Emballage externe :



500 ± 2,9 Kg



FABRIQUÉ
EN ESPAGNE

www.bicgraphic.eu



CLIC STIC STYLUS B_GUARD™ ANTIBACTERIAL

NOUVEAU

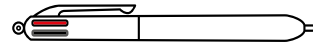

PROTECTION ANTI-BACTÉRIENNE



PROTECTION SUR TOUTE LA SURFACE DU STYLO



PROTECTION À VIE



TESTÉ PAR UN PROTOCOLE ANTIBACTÉRIEN

MIX & MATCH



Premier stylo antibactérien !

1848 Opaque



01

03

Couleur d'encre



Encre rouge disponible sur demande



07 100%



02

1848 Opaque



01 100%

Uniquement disponible en corps blanc

Commande minimale 500u.

Combinaison de couleurs standards

Bouton

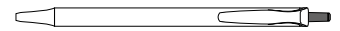

OPAQUE



Clip

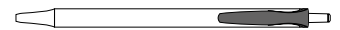

OPAQUE

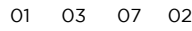

Section

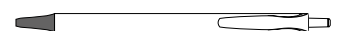

OPAQUE



Corps



OPAQUE



Injection d'une couleur spéciale :

≥ 10.000 unités

Le Bonhomme BIC® iconique et le logo antibactérien toujours visibles !

Instruments d'écriture BIC® • STYLOS

Disponible dans certains pays uniquement. Veuillez contacter votre attaché de clientèle pour plus d'information

Personnalisation :

BIC® CLIC STIC STYLUS BGUARD™ ANTIBACTERIAL

1848

A SP : max. 2 col.

B SP : max. 1 col.

C DG : Numérique (Uniquement disponible en corps blanc)

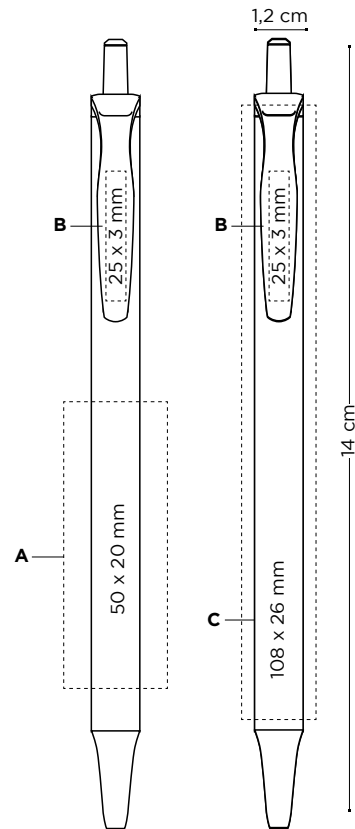

	Prix (€)			
BIC® CLIC STIC STYLUS BGUARD™ ANTIBACTERIAL	500-999	1000-2499	2500-4999	5000
1848				
SP	0,97	0,90	0,85	0,79
DG	1,22	1,13	1,06	1,00

Frais d'impression supplémentaires par couleur et position

SP	0,13	0,13	0,13	0,12
-----------	------	------	------	------

Les prix incluent une impression sur une position avec la technique indiquée.

Mode d'écriture :

Bille



M

Techniques d'impression :



(SP)
SÉRIGRAPHIE



(DG)
NUMÉRIQUE



Emballage spécial en option :



ECO Sleeve / Plastic Pouch

+ INFO pag. 236 & 237

Emballage externe :



500 ± 2,9 Kg



FABRIQUÉ
EN ESPAGNE

www.bicgraphic.eu



SUPER CLIP

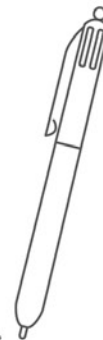

Un design élégant et polyvalent dans une grande variété de couleurs. Découvrez le clip aux nombreuses possibilités de personnalisations sur sa zone d'impression XXL, sur les versions standard, à valeur ajoutée et antibactérienne.

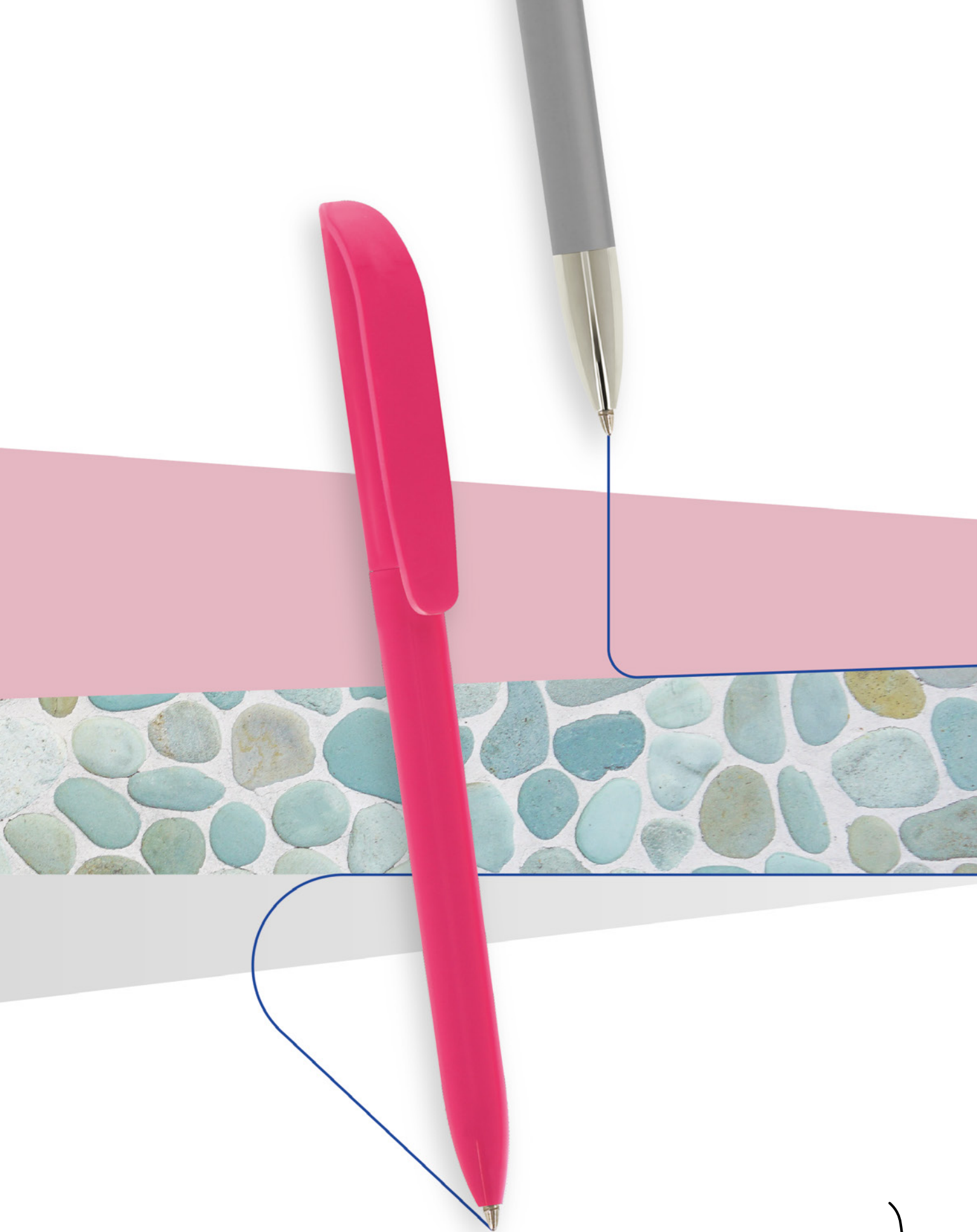

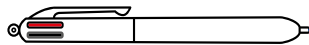

MIX & MATCH



1039 Opaque

01 8D* 2F* 1G 03 3H* 1P 84* 85* 2G* 83* 04 07 06 27* 02

Couleur d'encre

*Jusqu'à épuisement du stock

90%

Instruments d'écriture BIC • STYLOS

**48h non disponible en impression numérique





La solution pour une communication toute en couleur !

FABRIQUÉ À PARTIR DE 78% DE MATÉRIEL* RECYCLÉ ET 100% RECYCLABLE

1039 Transparent



*Pourcentage calculé sur le poids total du corps du stylo





Commande minimale 250u.

Combinaison de couleurs standards

Combinaison de couleurs standards
ECOolutions®

Clip

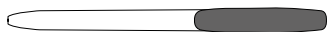

OPAQUE 01 8D 2F 1G 03 3H 1P 84 85 2G 83 04 07 06 27 02



TRANSPARENT 51 92 87 95 93 88 86 89

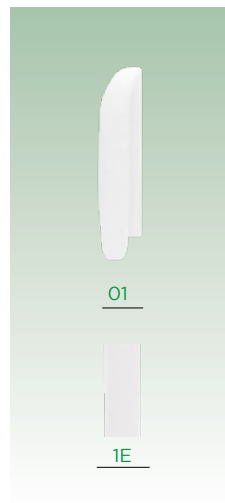

Ajoutez la boucle mobius sur votre BAT sans frais additionnels. Merci de le préciser dans votre bon de commande (en bas à gauche par défaut)

Corps



OPAQUE 01 8D 2F 1G 03 3H 1P 84 85 2G 83 04 07 06 27 02



TRANSPARENT 51 92 87 95 93 88 86 89

Injection d'une couleur spéciale :

≥ 10.000 unités

Mode d'écriture :

Techniques d'impression :

Emballage spécial en option :

Emballage externe :



M



(SP) SÉRIGRAPHIE



(DG) NUMÉRIQUE



(DG) britePix™



ECO Sleeve / Plastic Pouch / Window Box

+ INFO pag. 236 & 237



250 ± 2,6 Kg



FABRIQUÉ EN ESPAGNE

Personnalisation :

BIC® SUPER CLIP

1039

©©olutions® 1E50

A SP : max. 2 col.

B SP : max. 1 col.

1039

C DG : Numérique

D BP : Numérique

BP Texture : Numérique

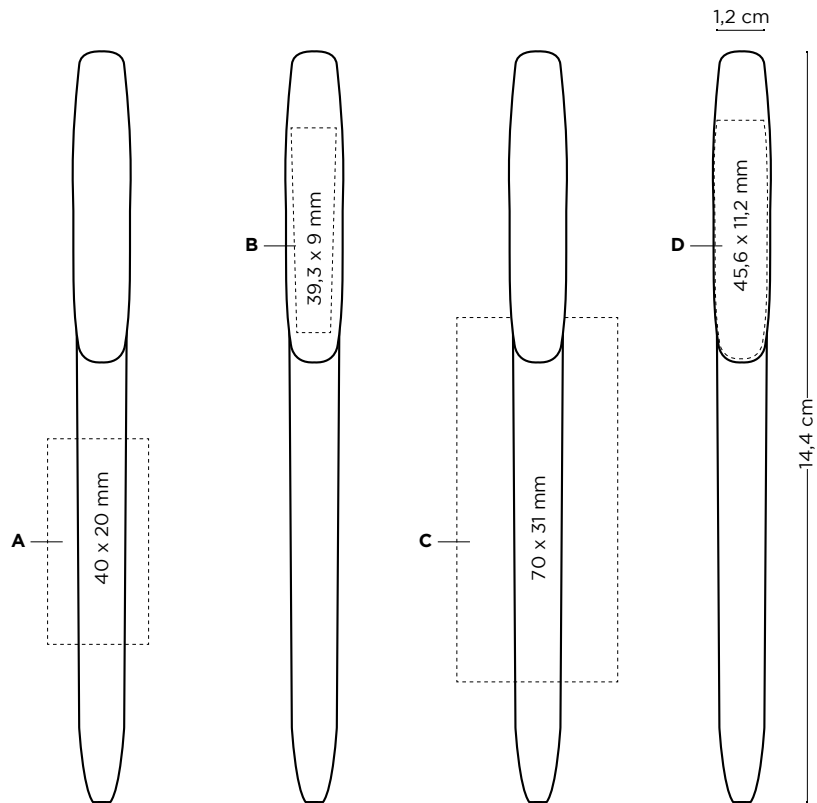

					Prix (€)
BIC® SUPER CLIP	250-499	500-999	1000-2499	2500-4999	5000
1039 / ©©olutions® 1E50					
SP	1,05	1,00	0,96	0,93	0,90
1039					
DG	1,36	1,31	1,25	1,21	1,17
BP	1,32	1,25	1,20	1,15	1,11

Frais d'impression supplémentaires par couleur et position

SP	0,16	0,13	0,13	0,13	0,12
BP	0,23	0,21	0,20	0,19	0,18
*BP Texture	0,17	0,15	0,14	0,14	0,13

Les prix incluent une impression sur une position avec la technique indiquée.

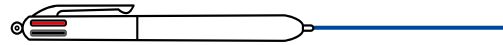

1040
Opaque

Le logo antibactérien toujours visible !



01 03 07 02 100%

Couleur d'encre

Commande minimale 250u.

Combinaison de couleurs standards

Clip

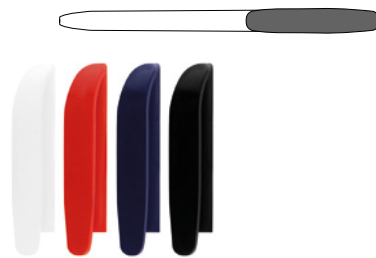

OPAQUE 01 03 07 02

Corps

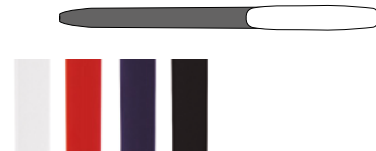

OPAQUE 01 03 07 02

Injection d'une couleur spéciale :

≥ 10.000 unités

**48h non disponible en impression numérique
Disponible dans certains pays uniquement. Veuillez contacter votre attaché de clientèle pour plus d'information

Personnalisation :

BIC® SUPER CLIP BGUARD™ ANTIBACTERIAL

1040

A/B SP : max. 1 col.

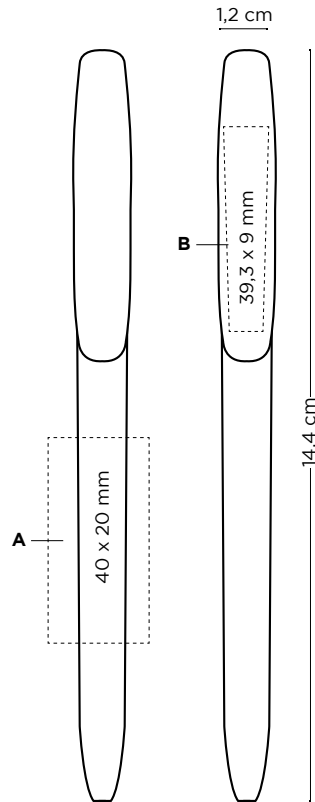

	Prix (€)				
BIC® SUPER CLIP BGUARD™ ANTIBACTERIAL	250-499	500-999	1000-2499	2500-4999	5000
1040					
SP	1,10	1,05	1,01	0,98	0,95
Frais d'impression supplémentaires par couleur et position					
SP	0,16	0,13	0,13	0,13	0,12

Les prix incluent une impression sur une position avec la technique indiquée.

Mode d'écriture :



M

Techniques d'impression :



(SP)
SÉRIGRAPHIE

Emballage spécial en option :



ECO Sleeve / Plastic Pouch / Window Box

+ INFO pag. 236 & 237

Emballage externe :



250 ± 2,6 Kg



FABRIQUÉ EN ESPAGNE

www.bicgraphic.eu

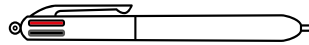

MIX & MATCH



1073 Opaque



**48h non disponible en impression numérique





La solution pour une
communication toute en couleur !

Mécanisme pivotant
silencieux !



*Jusqu'à
épaulement
du stock

BIC® SUPER CLIP ADVANCE DIGITAL
1073 Opaque



Uniquement disponible
en corps blanc



www.bicgraphic.eu

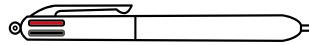

Commande minimale 250u.

Combinaison de couleurs standards

Clip



OPAQUE 01 2F 1G 03 3H 1P 2G 04 07 06 27 02



TRANSPARENT 51 92 87 95 93 88 86 89

Corps



OPAQUE 01 2F 1G 03 3H 1P 2G 04 07 06 27 02

Section

ADVANCE



35

Injection d'une couleur spéciale :

≥ 10.000 unités

Mode d'écriture :



Techniques d'impression :



(SP) SÉRIGRAPHIE



(DG) NUMÉRIQUE



(DG) britePix™



Emballage spécial en option :



ECO Sleeve / Plastic Pouch / Window Box

Emballage externe :



500 ± 3,9 Kg

Regardez la video



FABRIQUÉ EN ESPAGNE



Personnalisation :

BIC® SUPER CLIP ADVANCE

1073

A SP : max. 2 col.

B SP : max. 1 col.

C DG : Numérique

D BP : Numérique

BP Texture : Quadrichromie

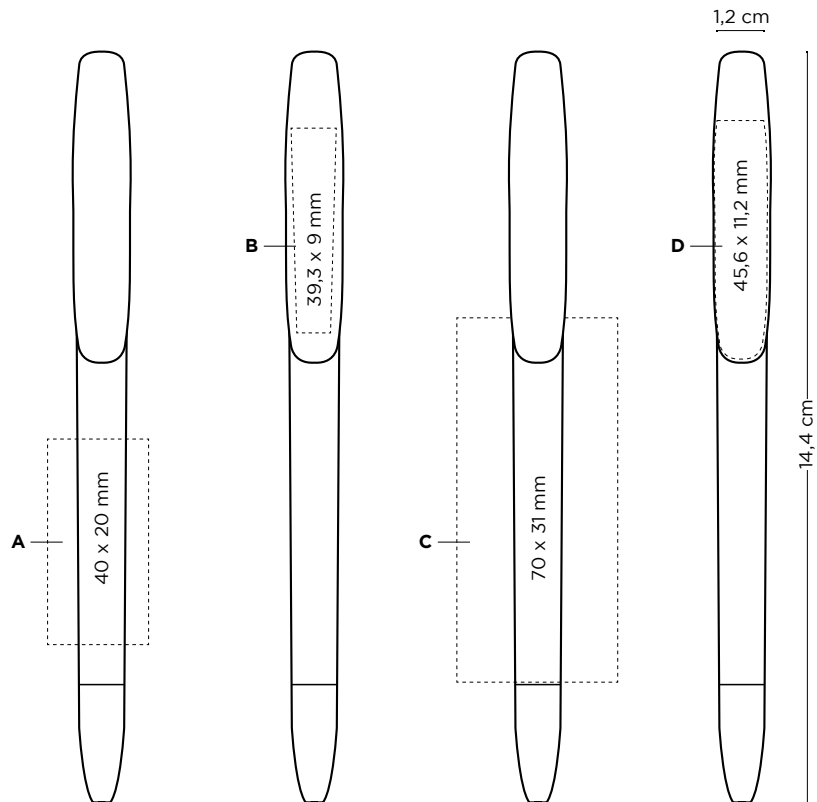

BIC® SUPER CLIP ADVANCE	250-499	500-999	1000-2499	2500-4999	Prix (€)
1073					5000
SP	1,47	1,40	1,34	1,30	1,25
DG	1,79	1,69	1,62	1,57	1,52
BP	1,69	1,60	1,53	1,48	1,43

Frais d'impression supplémentaires par couleur et position

SP	0,16	0,13	0,13	0,13	0,12
BP	0,23	0,21	0,2	0,19	0,18
*BP Texture	0,17	0,15	0,14	0,14	0,13

Les prix incluent une impression sur une position avec la technique indiquée.



WIDE BODY

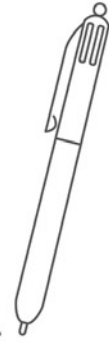

La taille idéale pour mettre en valeur votre marque !
Corps large et multiples possibilités pour optimiser
votre communication.

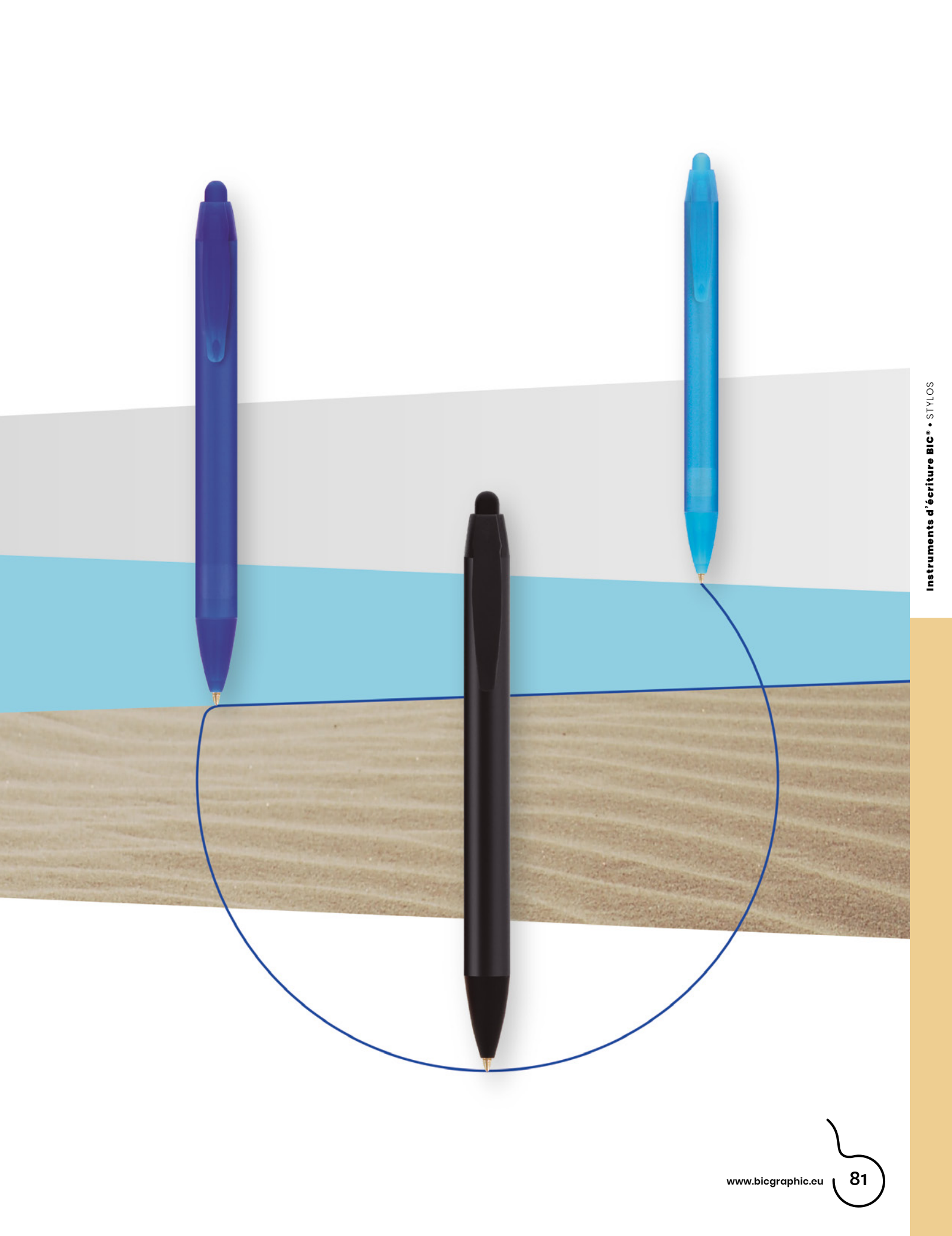

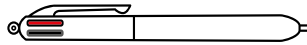

MIX & MATCH



l'icône BIC® Boy est en relief

1080 Opaque



Couleur d'encre

Encre rouge disponible sur demande

18

100%

1E

100%

ecolutions®



FABRIQUÉ À PARTIR DE 94% DE MATÉRIEL* RECYCLÉ ET EST **100% RECYCLABLE**

Fabriqué à partir de cagettes plastiques de fruits et légumes



ecolutions®
1E80 Opaque



1E

100%

*Pourcentage calculé sur le poids total du corps du stylo



**48h non disponible en impression numérique

1080 Givré



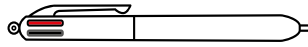

La solution pour une **communication toute en couleur !**

BIC® WIDE BODY™ DIGITAL 1080 / 1E80 Opaque	BIC® WIDE BODY™ MINI DIGITAL 1893 Opaque	BIC® WIDE BODY™ CHROME MINI DIGITAL 1896 Opaque
<p>68</p> <p>03</p> <p>100%</p>	<p>01</p> <p>01</p> <p>100%</p> <p>Uniquement disponible en corps blanc</p>	<p>01</p> <p>01</p> <p>100%</p>

*48h non disponible en impression numérique



COMMANDE MINIMALE 250u.

Combinaison de couleurs standards

Bouton



*uniquement disponible en version digitale (*Jusqu'à épuisement du stock)

Clip

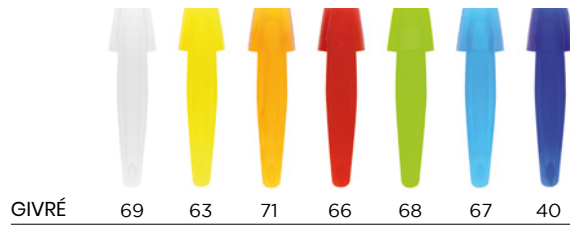
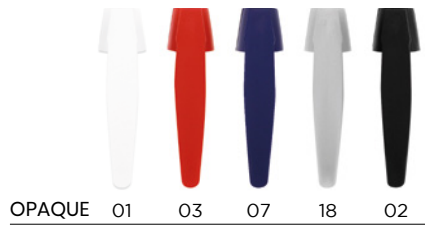
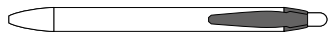

Corps

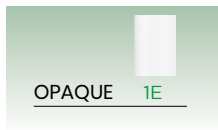
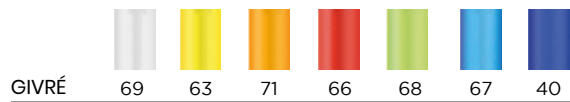
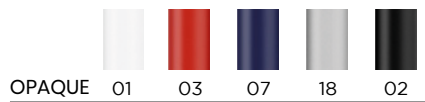

Ajoutez la boucle mobius sur votre BAT sans frais additionnels. Merci de le préciser dans votre bon de commande (en bas à gauche par défaut)

Section

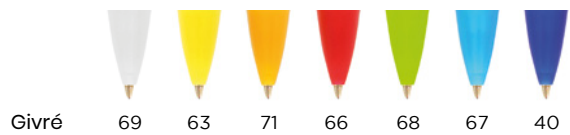
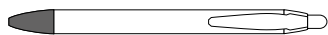

*uniquement disponible en version digitale (*Jusqu'à épuisement du stock)

Injection d'une couleur spéciale :

≥ 10.000 unités

Mode d'écriture :

Techniques d'impression :

Bille



M



(SP) SÉRIGRAPHIE



(DG) NUMÉRIQUE



www.bicgraphic.eu

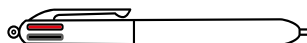

Personnalisation :

BIC® WIDE BODY™
1080
eCOlutions® 1E80

- A/C SP :** max. 2 col.
- B/F SP :** max. 1 col.
- D DG :** Numérique (zone image)
- E DG :** Numérique (zone texte)

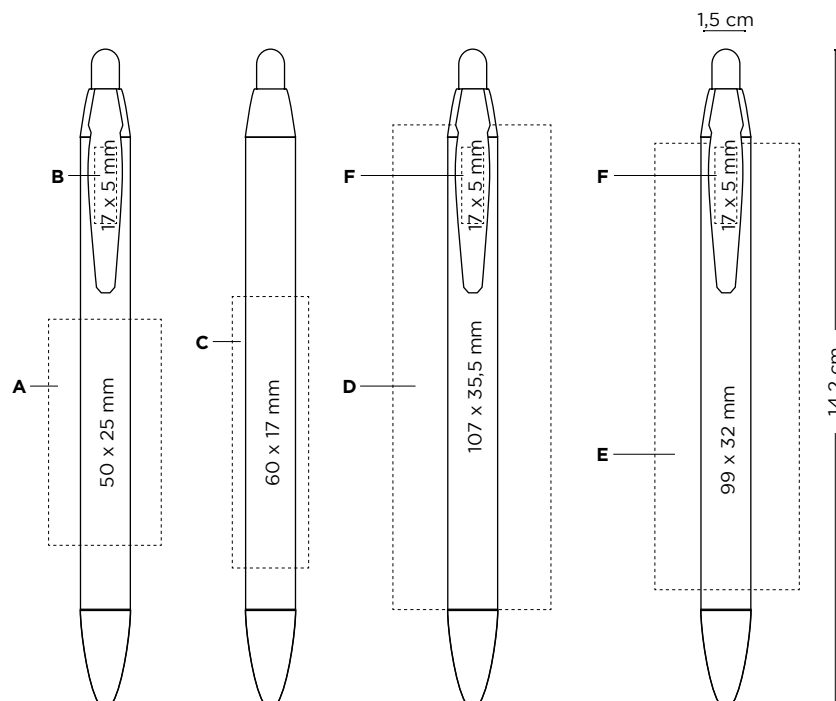

BIC® WIDE BODY™ 1080 / eCOlutions® 1E80	250-499	500-999	1000-2499	2500-4999	Prix (€)
SP	1,08	0,99	0,93	0,87	0,80
DG	-	1,38	1,28	1,19	1,12

Frais d'impression supplémentaires par couleur et position

SP	0,16	0,13	0,13	0,13	0,12
-----------	------	------	------	------	------

Les prix incluent une impression sur une position avec la technique indiquée.

Emballage spécial en option :



ECO Sleeve / Plastic Pouch / Window Box

Emballage externe :



250 ± 2,6 Kg



FABRIQUÉ EN ESPAGNE

BIC® WIDE BODY™ MINI DIGITAL

1893

BIC® WIDE BODY™ MINI CHROME DIGITAL

1896

A DG : Numérique (zone image)

B DG : Numérique (zone texte)

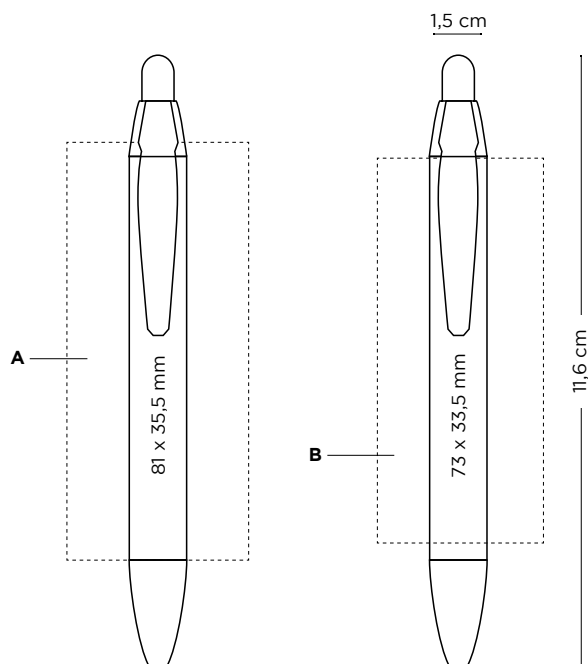

				Prix (€)
BIC® WIDE BODY™ MINI DIGITAL	500-999	1000-2499	2500-4999	5000
1893				
DG	1,21	1,13	1,06	1,00
1896				
DG	2,10	1,96	1,86	1,71

Les prix incluent l'impression numérique sur le corps.

**Emballage
externe :**



250 ± 1,9 Kg



**FABRIQUÉ
EN ESPAGNE**



1081
Opaque



01 03

Couleur d'encre
Encre rouge disponible sur demande



07 100%



02

1081
Opaque



01 100%

COMMANDE MINIMALE 250u.

Combinaison de couleurs standards

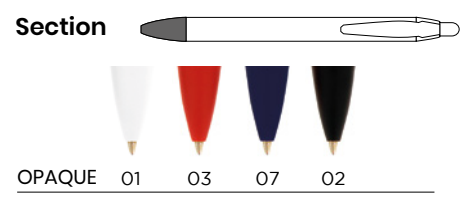
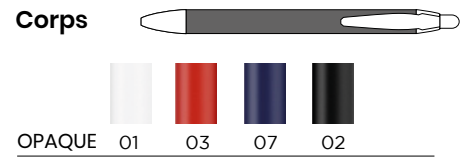
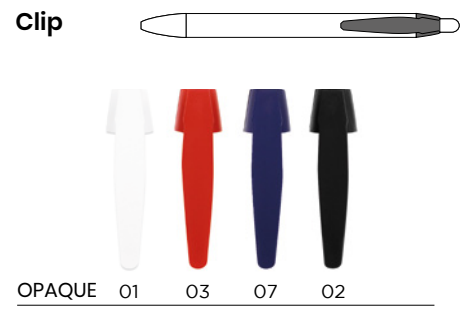
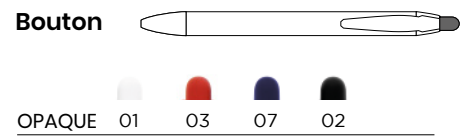

Injection d'une couleur spéciale :

≥ 10.000 unités

Le logo antibactérien toujours visible !

Instruments d'écriture BIC • STYLOS

**48h non disponible en impression numérique
Disponible dans certains pays uniquement. Veuillez contacter votre attaché de clientèle pour plus d'information

Personnalisation :

BIC® WIDE BODY™ BGUARD™ ANTIBACTERIAL
1081

- A/C SP :** max. 1 col.
- B/F SP :** max. 1 col.
- D DG :** Numérique (zone image)
- E DG :** Numérique (zone texte)

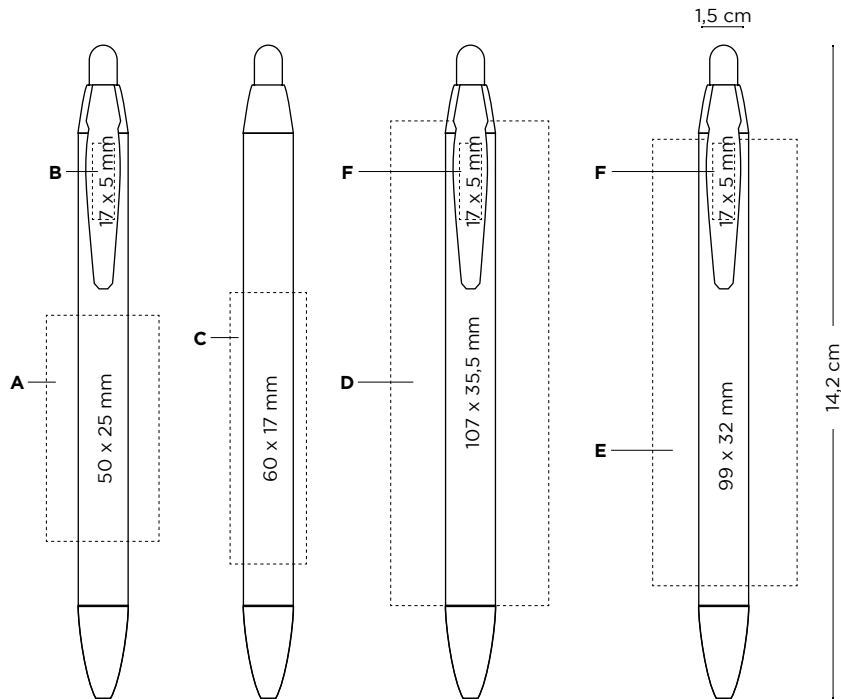

	Prix (€)				
BIC® WIDE BODY™ BGUARD™ ANTIBACTERIAL	250-499	500-999	1000-2499	2500-4999	5000
1081					
SP	1,13	1,04	0,98	0,91	0,84
DG	-	1,45	1,34	1,25	1,18

Frais d'impression supplémentaires par couleur et position					
SP	0,16	0,13	0,13	0,13	0,12

Les prix incluent une impression sur une position avec la technique indiquée.

Mode d'écriture :



M

Techniques d'impression :



(SP)
SÉRIGRAPHIE



(DG)
NUMÉRIQUE



Emballage spécial en option :



ECO Sleeve / Plastic Pouch / Window Box

+ INFO pag. 236 & 237

Emballage externe :



250 ± 2,6 Kg



FABRIQUÉ EN ESPAGNE

www.bicgraphic.eu

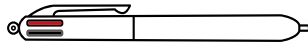

1053 Opaque

 L'icône BIC® Boy est en relief



07*



02



01/03*



01/07*

Couleur d'encre

*Jusqu'à épuisement du stock



01/02*



1053 Transparent



51/07



51/02*



Grip au toucher doux, très bonne prise en main

Commande minimale 250u.

Combinaison de couleurs standards

Personnalisation :

BIC® ATLANTIS®

1053

A PD : max. 1 col.

B/C SP : max. 2 col.

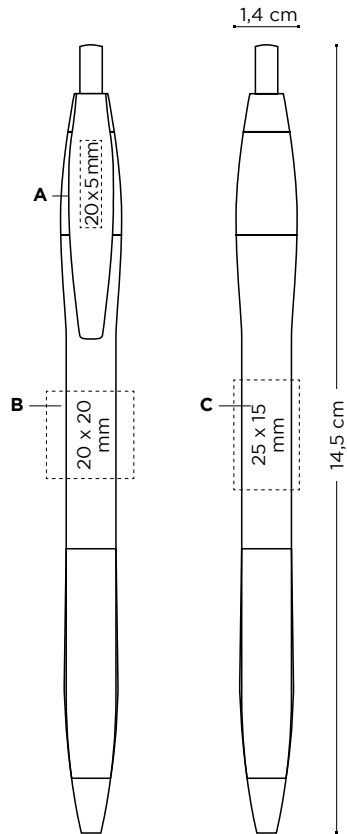

	250-499	500-999	1000-2499	2500-4999	Prix (€)
BIC® ATLANTIS®					5000
1053					
SP/PD	1,41	1,28	1,18	1,10	1,04

Frais d'impression supplémentaires par couleur et position

SP/PD	0,16	0,13	0,13	0,13	0,12
--------------	------	------	------	------	------

Les prix incluent une impression sur une position avec la technique indiquée.

Mode d'écriture :



M

Techniques d'impression :



(SP)
SÉRIGRAPHIE



(PD)
TAMPOGRAPHIE

Emballage spécial en option :



ECO Sleeve / Plastic Pouch / Window Box

+ INFO pag. 236 & 237

Emballage externe :



250 ± 2,3 Kg





BIC® 4 COLOURS

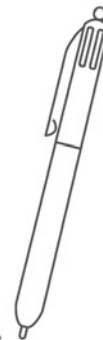

Le stylo à bille de renommée mondiale BIC® 4 Colours vous offre la commodité de quatre couleurs d'encre différentes dans un seul stylo à bille, ce qui en fait un excellent choix pour organiser des notes ou des données selon les différentes couleurs. Ce stylo polyvalent a une pointe moyenne de 1 mm et une grande longueur d'écriture. Pour plus de commodité, il est doté d'un trou pour passer un cordon, vous pouvez donc l'emporter partout avec vous. Découvrez toutes les différentes versions: Classic, Fashion, Sun, Fine, Mini, Shine, Fluo, Stylus, 3 + 1 (avec porte-mine) et la dernière version glamour Glacé

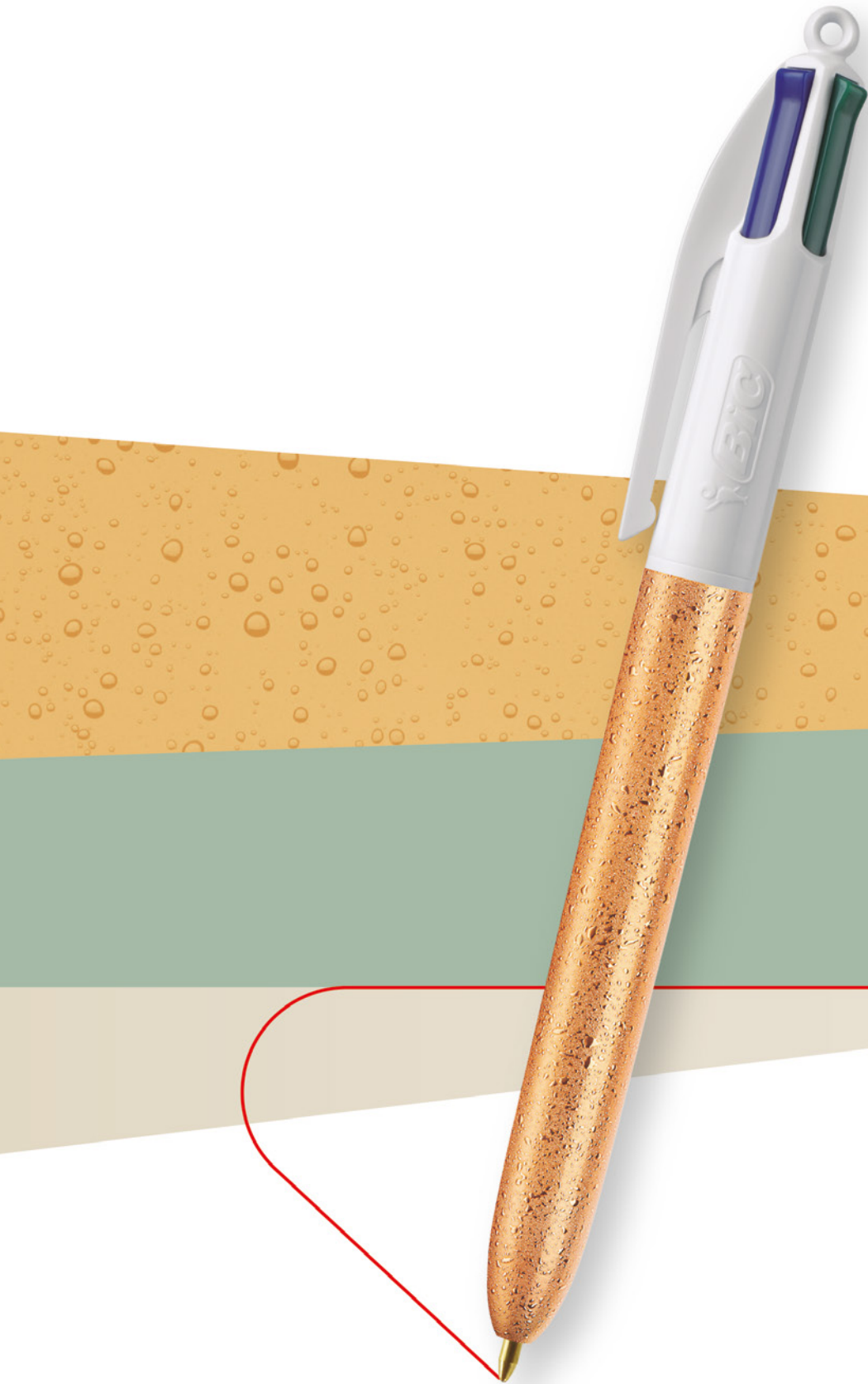

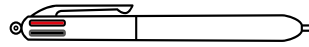

britepix
DIGITAL La solution pour
une communication toute **en couleur**

BIC Graphic Europe le pionnier du marquage numérique

1100
4 Colours





1102
4 Colours Fashion



01/01

01/24

01/84

02/02



1097
4 Colours Sun



01/12



1109
4 Colours Fine



01/10



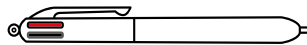

BIC® 4 COLOURS
 1100 Opaque
 1101 Avec tour de cou



*48h non disponible en impression numérique
 Disponible sans tour de cou



Commande minimale 250u.

Personnalisation :

BIC® 4 COLOURS

1100

A SP : max. 4 col.

B DG : Digital print (zone image)

C BP : Numérique

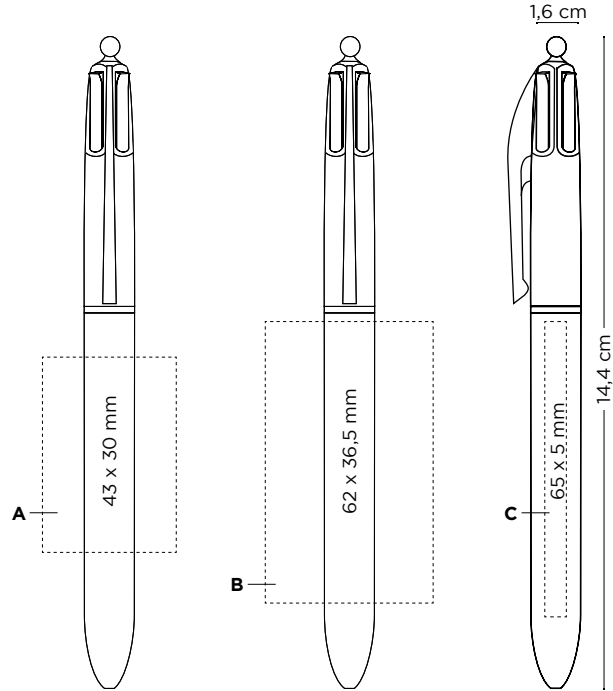

	100-249	250-499	500-999	1000-2499	2500-4999	5000	Prix (€)
BIC® 4 COLOURS							
1100							
SP	-	3,06	2,77	2,56	2,40	2,26	
DG	-	4,18	3,79	3,51	3,27	3,09	
BP	4,05	3,30	2,99	2,78	2,60	2,45	
1101 (tour de cou)							
SP	-	3,47	3,14	2,90	2,73	2,56	
DG	-	4,59	4,16	3,85	3,59	3,40	
BP	4,54	3,71	3,36	3,12	2,93	2,76	

Frais d'impression supplémentaires par couleur et position

SP	-	0,16	0,13	0,13	0,13	0,12
BP	0,25	0,23	0,21	0,20	0,19	0,18
BP Texture	0,19	0,17	0,15	0,14	0,14	0,13

Les prix incluent une impression sur une position avec la technique indiquée.

Mode d'écriture :

Bille



M

Techniques d'impression :

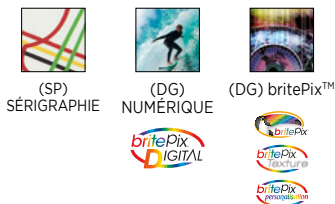

Emballage spécial en option :



+ INFO pag. 236 & 237

Emballage externe :



250 ± 3,2 Kg

Regardez la video



FABRIQUÉ EN FRANCE

www.bicgraphic.eu





4 COLOURS MINI

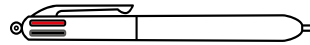

BIC® 4 COLOURS MINI

1103 Opaque

1104 Avec tour de cou



Couleur d'encre
● ● ● ●
● ● ● ●
● ● ● ●

100%
● ● ● ●
● ● ● ●
● ● ● ●

Iconique BIC® Boy est en relief

Commande minimale 250u.

Personnalisation :

BIC® 4 COLOURS MINI

1103

D SP : max. 4 col.

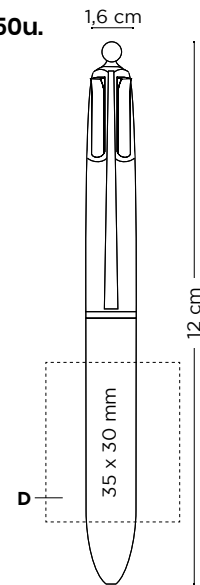

	250-499	500-999	1000-2499	2500-4999	Prix (€)
BIC® 4 COLOURS MINI					5000
1103					
SP	3,25	2,95	2,74	2,55	2,41
1104 (tour de cou)					
SP	3,69	3,34	3,10	2,90	2,74

Frais d'impression supplémentaires par couleur et position

SP	0,16	0,13	0,13	0,13	0,12
-----------	------	------	------	------	------

Les prix incluent la sérigraphie 1 couleur sur un emplacement.

Mode d'écriture :



M

*48h non disponible en impression numérique
Disponible sans tour de cou
www.bicgraphic.eu

Techniques d'impression :



(SP)
SÉRIGRAPHIE

Emballage externe :



250 ± 2,7 Kg



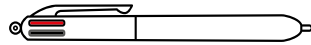

BIC® 4 COLOURS SUN
1097 Opaque
1098 Avec tour de cou

Flashy:
orange et jaune



Commande minimale 250u.

Personnalisation :

BIC® 4 COLOURS SUN

1097

A SP : max. 4 col.

B DG : Digital print
(zone image)

C BP : Numérique

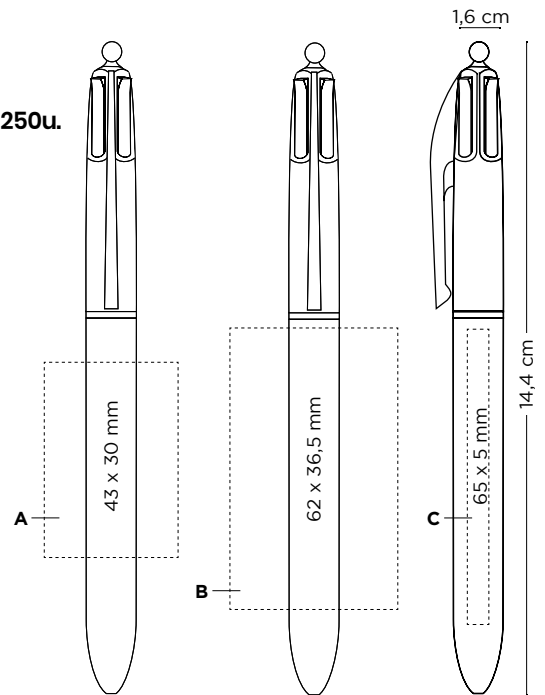

Prix (€)

BIC® 4 COLOURS SUN	100-249	250-499	500-999	1000-2499	2500-4999	5000
1097						
SP	-	3,06	2,77	2,56	2,40	2,26
DG	-	4,18	3,79	3,51	3,27	3,09
BP	4,05	3,30	2,99	2,78	2,60	2,45
1098 (tour de cou)						
SP	-	3,47	3,14	2,90	2,73	2,56
DG	-	4,59	4,16	3,85	3,59	3,40
BP	4,54	3,71	3,36	3,12	2,93	2,76

Frais d'impression supplémentaires par couleur et position

SP	-	0,16	0,13	0,13	0,13	0,12
BP	0,25	0,23	0,21	0,20	0,19	0,18
BP Texture	0,19	0,17	0,15	0,14	0,14	0,13

Les prix incluent une impression sur une position avec la technique indiquée.

Mode d'écriture :

Bille



M

*48h non disponible en impression numérique
Disponible sans tour de cou

Techniques d'impression :



(SP) SÉRIGRAPHIE



(DG) NUMÉRIQUE



(DG) britePix™



Emballage spécial en option :



ECO Sleeve / Plastic Pouch / Window Box

Emballage externe :



250 ± 3,2 Kg



FABRIQUÉ EN FRANCE



+ INFO pag. 236 & 237

www.bicgraphic.eu

99

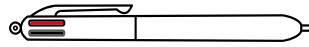

BIC® 4 COLOURS FASHION
 1102 Opaque
 1108 Avec tour de cou

Encres Fashion



Couleur d'encre

01/01

01/24

01/84

02/02

100%

*48h non disponible en impression numérique
 Disponible sans tour de cou



Commande minimale 250u.

Personnalisation :

BIC® 4 COLOURS FASHION

1102

A SP : max. 4 col.

B DG : Digital print (zone image)

C BP : Numérique

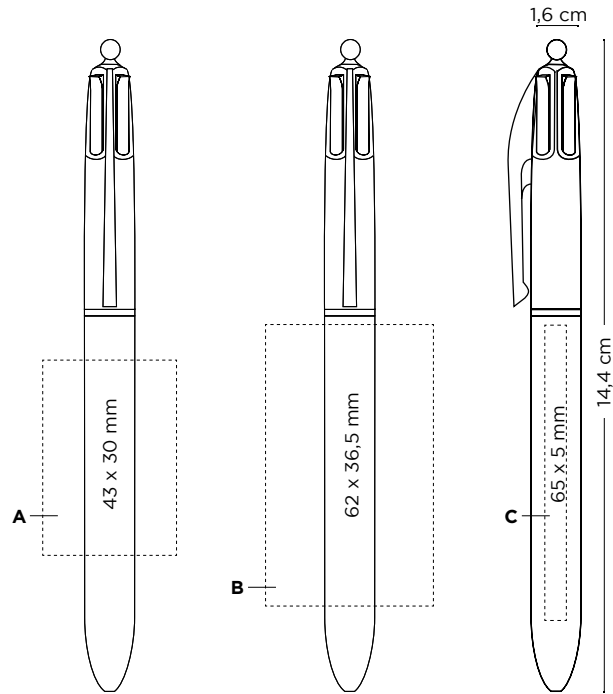

	Prix (€)					
BIC® 4 COLOURS FASHION	100-249	250-499	500-999	1000-2499	2500-4999	5000
1102						
SP	-	3,06	2,77	2,56	2,40	2,26
DG	-	4,18	3,79	3,51	3,27	3,09
BP	4,05	3,30	2,99	2,78	2,60	2,45
1108 (tour de cou)						
SP	-	3,47	3,14	2,90	2,73	2,56
DG	-	4,59	4,16	3,85	3,59	3,40
BP	4,54	3,71	3,36	3,12	2,93	2,76

Frais d'impression supplémentaires par couleur et position

SP	-	0,16	0,13	0,13	0,13	0,12
BP	0,25	0,23	0,21	0,20	0,19	0,18
BP Texture	0,19	0,17	0,15	0,14	0,14	0,13

Les prix incluent une impression sur une position avec la technique indiquée.

Mode d'écriture :



M

Techniques d'impression :



(SP) SÉRIGRAPHIE



(DG) NUMÉRIQUE



(DG) britePix™



Emballage spécial en option :



ECO Sleeve / Plastic Pouch / Window Box

+ INFO pag. 236 & 237

Emballage externe :



250 ± 3,2 Kg



FABRIQUÉ EN FRANCE

www.bicgraphic.eu

101



4 COLOURS SHINE

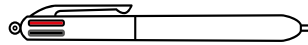

BIC® 4 COLOURS SHINE
1106 Opaque
1107 Avec tour de cou



Corps super brillant!

Instruments d'écriture BIC® • STYLOS



Commande minimale 250u.

Personnalisation :

BIC® 4 COLOURS SHINE

1106

A SP : max. 2 col.

B LE

C LE

D LE 360°

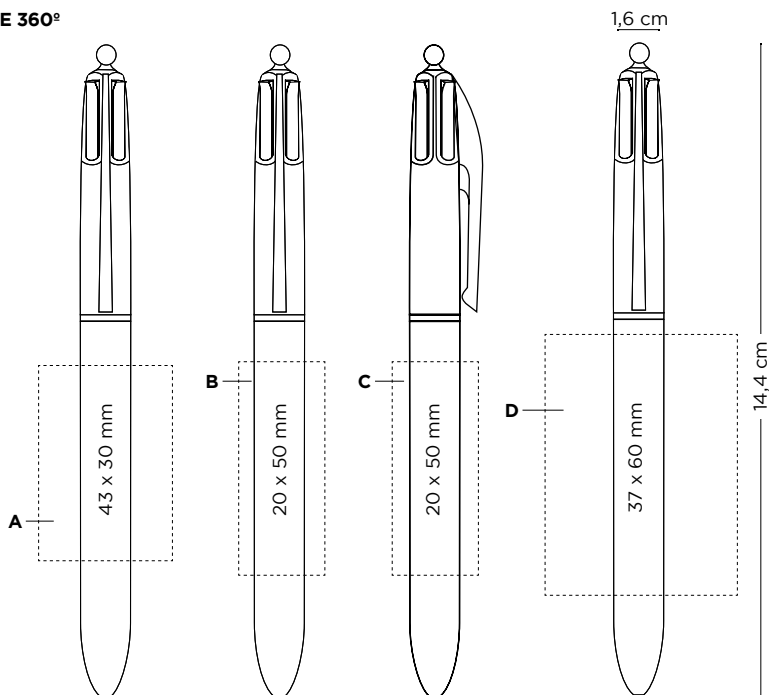

	Prix (€)				
BIC® 4 COLOURS SHINE	250-499	500-999	1000-2499	2500-4999	5000
1106					
SP	3,50	3,15	2,93	2,74	2,56
LE	4,30	3,87	3,59	3,35	3,16
LE 360°	4,88	4,39	4,09	3,81	3,58
1107 (tour de cou)					
SP	3,93	3,54	3,29	3,09	2,89
LE	4,73	4,26	3,96	3,70	3,49
LE 360°	5,31	4,79	4,45	4,16	3,91

Frais d'impression supplémentaires par couleur et position

SP	0,16	0,13	0,13	0,13	0,12
-----------	------	------	------	------	------

Les prix incluent une impression sur une position avec la technique indiquée.

Mode d'écriture :



M

Techniques d'impression :



(SP)
SÉRIGRAPHIE



(LE)
LASER

Emballage spécial en option :



ECO Sleeve / Plastic Pouch / Window Box

Emballage externe :



250 ± 3,2 Kg



FABRIQUÉ EN FRANCE

www.bicgraphic.eu



4 COLOURS GLACÉ

NOUVEAU

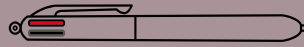

WOW

BIC® 4 COLOURS GLACÉ
1057 Opaque
1058 Avec tour de cou

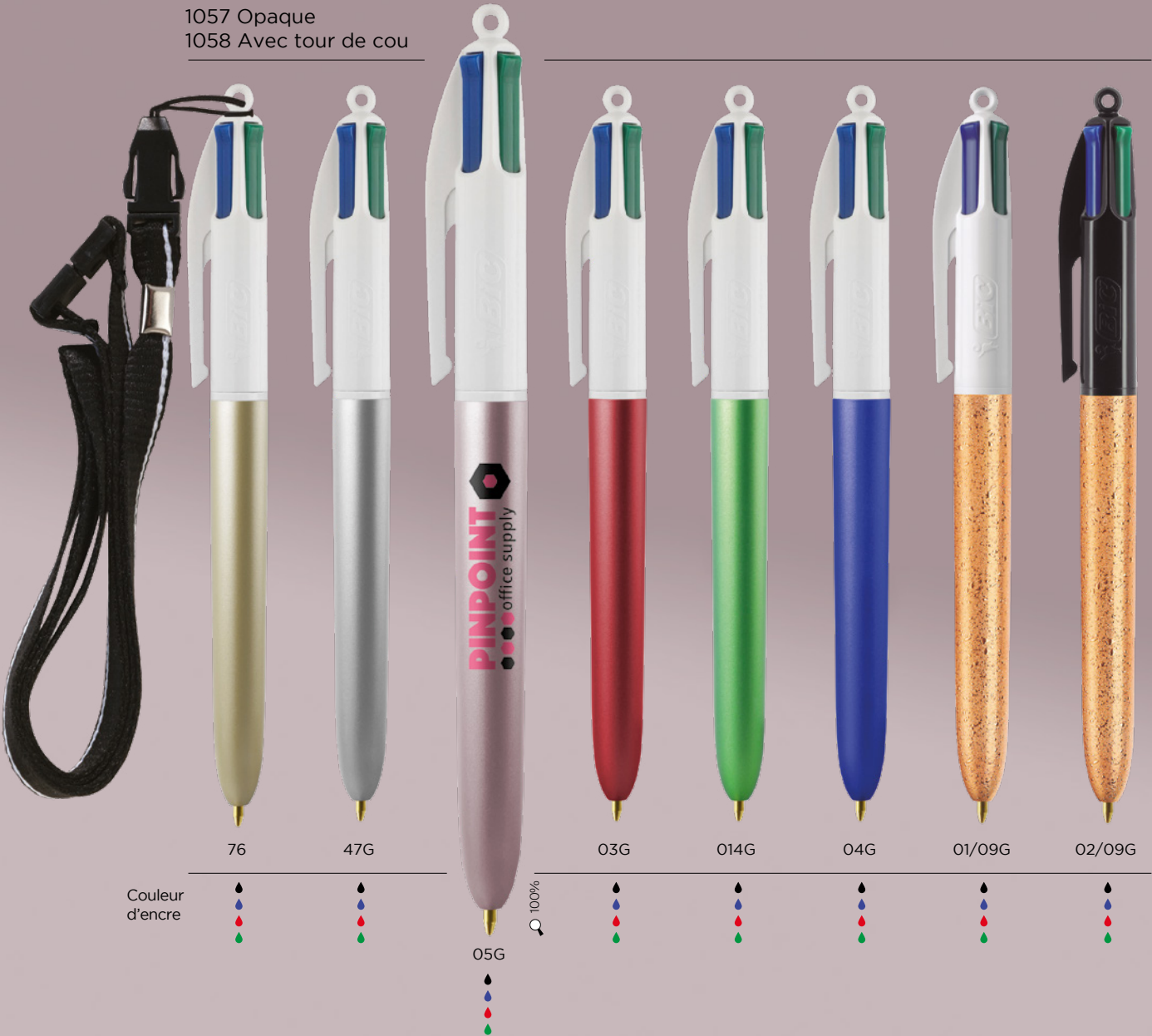

Couleur d'encre



100%



Commande minimale 250u.

Personnalisation :

BIC® 4 COLOURS GLACÉ

1057

A SP : max. 2 col. (Glacé)

B LE : (Glacé Granité)

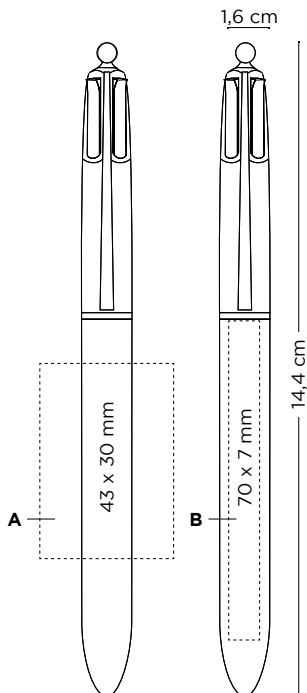

	Prix (€)				
BIC® 4 COLOURS GLACÉ	250-499	500-999	1000-2499	2500-4999	5000
1057					
SP	3,50	3,15	2,93	2,74	2,56
LE	4,30	3,87	3,59	3,35	3,16
1058 (tour de cou)					
SP	3,91	3,52	3,27	3,07	2,87
LE	4,71	4,24	3,93	3,68	3,47

Frais d'impression supplémentaires par couleur et position

SP	0,16	0,13	0,13	0,13	0,12
-----------	------	------	------	------	------

Les prix incluent une impression sur une position avec la technique indiquée.

Mode d'écriture :



M

Techniques d'impression :



(SP)
SÉRIGRAPHIE



(LE)
LASER

Emballage spécial en option :



ECO Sleeve / Plastic Pouch / Window Box

Emballage externe :



250 ± 3,2 Kg



FABRIQUÉ EN FRANCE

www.bicgraphic.eu

105

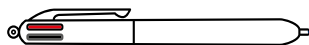

BIC® 4 COLOURS FINE
1109 Opaque
1111 Avec tour de cou



Commande minimale 250u.

Personnalisation :

BIC® 4 COLOURS FINE

1109

A SP : max. 4 col.

B DG : Digital print

C BP : Numérique

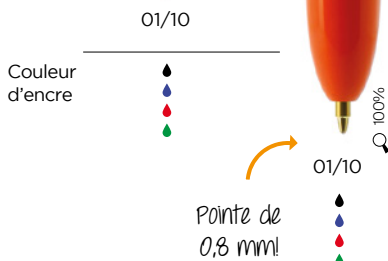
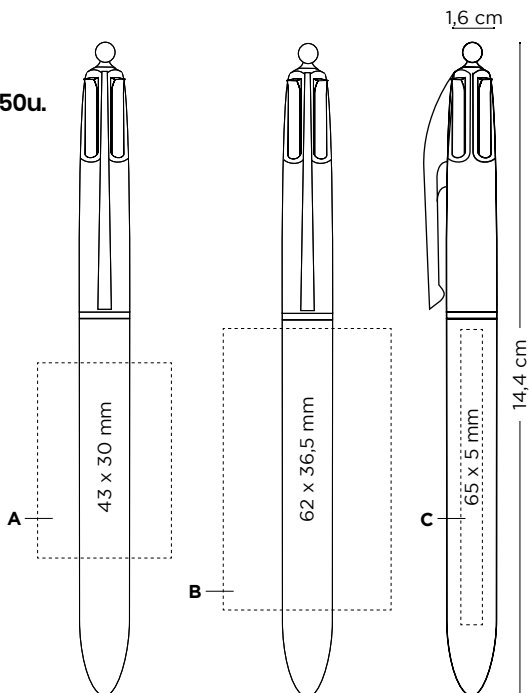

	Prix (€)					
BIC® 4 COLOURS FINE	100-249	250-499	500-999	1000-2499	2500-4999	5000
1109						
SP	-	3,06	2,77	2,56	2,40	2,26
DG	-	4,18	3,79	3,51	3,27	3,09
BP	4,05	3,30	2,99	2,78	2,60	2,45
1111 (tour de cou)						
SP	-	3,47	3,14	2,90	2,73	2,56
DG	-	4,59	4,16	3,85	3,59	3,40
BP	4,54	3,71	3,36	3,12	2,93	2,76

Frais d'impression supplémentaires par couleur et position

SP	-	0,16	0,13	0,13	0,13	0,12
BP	0,25	0,23	0,21	0,20	0,19	0,18
BP Texture	0,19	0,17	0,15	0,14	0,14	0,13

Les prix incluent une impression sur une position avec la technique indiquée.

Mode d'écriture :



F

Techniques d'impression :



(SP) SÉRIGRAPHIE



(DG) NUMÉRIQUE



(DG) britePix™

Emballage spécial en option :



ECO Sleeve / Plastic Pouch / Window Box

Emballage externe :



250 ± 3,2 Kg



FABRIQUÉ EN FRANCE



*48h non disponible en impression numérique
Disponible sans tour de cou

www.bicgraphic.eu

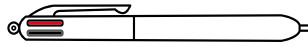

BIC® 4 COLOURS FLUO
1114 Opaque
1116 Avec tour de cou



Encre jaune fluo!

Commande minimale 250u.

Personnalisation :

BIC® 4 COLOURS FLUO

1114

A SP : max. 4 col.

B BP : Numérique

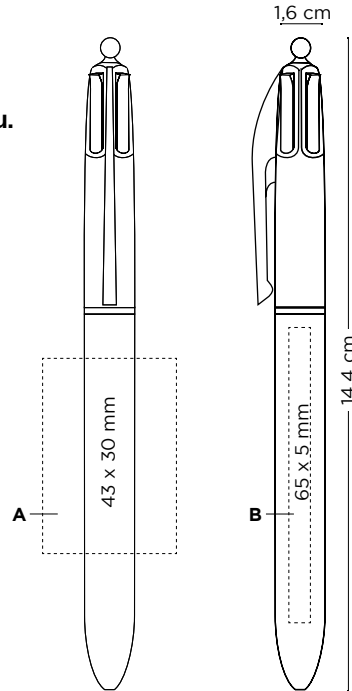

	100-249	250-499	500-999	1000-2499	2500-4999	Prix (€)
BIC® 4 COLOURS FLUO						5000
1114						
SP	-	3,31	2,99	2,77	2,59	2,45
BP	4,05	3,55	3,21	2,98	2,79	2,64
1116 (tour de cou)						
SP	-	3,75	3,39	3,13	2,94	2,78
BP	4,85	3,99	3,61	3,34	3,14	2,97

Frais d'impression supplémentaires par couleur et position

SP	-	0,16	0,13	0,13	0,13	0,12
BP	0,25	0,23	0,21	0,20	0,19	0,18
BP Texture	0,19	0,17	0,15	0,14	0,14	0,13

Les prix incluent une impression sur une position avec la technique indiquée.

Mode d'écriture :



B

*48h non disponible en impression numérique
Disponible sans tour de cou

Techniques d'impression :



(SP) SÉRIGRAPHIE



(DG) NUMÉRIQUE



(DG) britePix™



Emballage spécial en option :



ECO Sleeve / Plastic Pouch / Window Box

+ INFO pag. 236 & 237

Emballage externe :



250 ± 3,2 Kg



FABRIQUÉ EN FRANCE



www.bicgraphic.eu

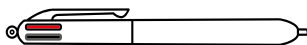

BIC® 4 COLOURS STYLUS
1112 Opaque

Extrémité en caoutchouc pour écran tactile !



Commande minimale 250u.

Personnalisation :

BIC® 4 COLOURS STYLUS

1112

A SP : max. 1 col.

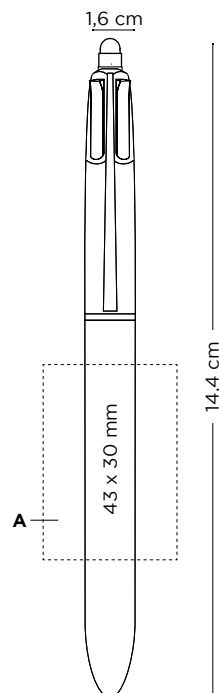

02/02

Couleur d'encre



02/02



100%

BIC® 4 COLOURS STYLUS

1112

SP

250-499

500-999

1000-2499

2500-4999

Prix (€)

5000

3,64

3,29

3,05

2,85

2,69

Les prix incluent la sérigraphie 1 couleur sur un emplacement.

Mode d'écriture :

Bille



M

Techniques d'impression :



(SP) SÉRIGRAPHIE

Emballage spécial en option :



ECO Sleeve / Plastic Pouch

+ INFO pag. 236 & 237

Emballage externe :



250 ± 3,2 Kg



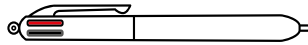

BIC® 4 COLOURS 3+1^{HB}
1099 Opaque



Commande minimale 250u.

Personnalisation :

BIC® 4 COLOURS 3+1^{HB}
1099
A/B LE

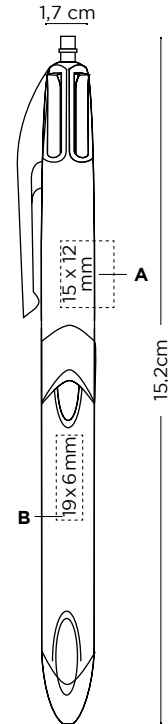

Couleur d'encre

01/06

100%

	Prix (€)				
BIC® 4 COLOURS 3+1^{HB}	250-499	500-999	1000-2499	2500-4999	5000
1099					
LE	4,60	4,15	3,86	3,59	3,40
Frais pour une gravure supplémentaire					
LE	1,21	1,09	0,96	0,96	0,96

Le prix comprend 1 gravure laser sur 1 position.

Mode d'écriture :

Bille & Porte-mine
M-MP
Ø0,7mm

Techniques d'impression :



Emballage spécial en option :



Plastic Pouch
+ INFO pag. 237

Emballage externe :



250 ± 3,5 Kg

Regardez la video



www.bicgraphic.eu



METAL PRO

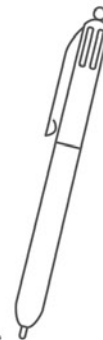

Attributs métalliques, design moderne avec un grand choix de couleurs et de finitions. Confort d'écriture maximal, cartouche métallique d'encre de fabrication allemande.



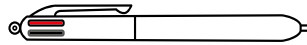

1290 Soft



01

10

03

05

04

08

02

Couleur
d'encre

1290
Brillant



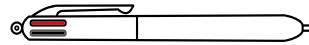

1290 Matte



01

10

03

05

04

08

02

Couleur
d'encre



Commande minimale 50u.

Personnalisation :

BIC® METAL PRO

1290

A SP : max. 2 col.

(Non disponible en finition soft)

B LE/SP : max. 1 col.

C LE 360°

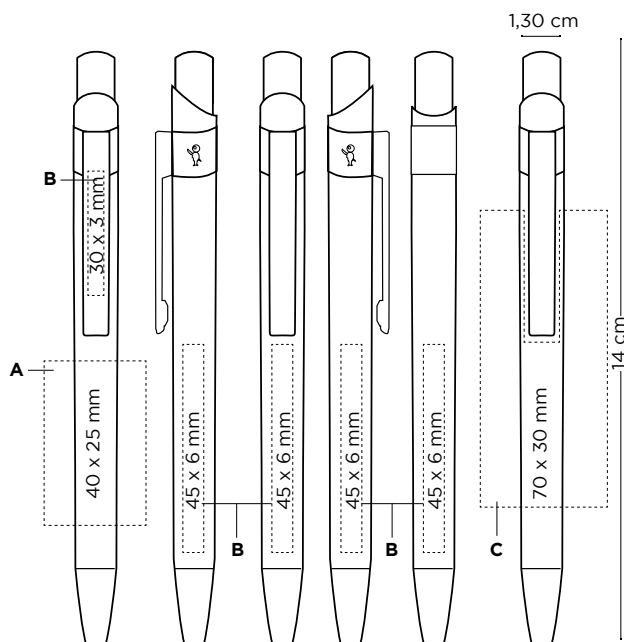

	Prix (€)						
BIC® METAL PRO	50-99	100-249	250-499	500-999	1000-2499	2500-4999	5000
1290							
SP	4,35	4,20	4,04	3,88	3,68	3,54	3,41
LE	5,50	5,15	4,92	4,69	4,43	4,29	4,16
LE 360° (Commande minimale 100u.)	-	6,23	5,90	5,57	5,20	5,06	4,93

Frais d'impression supplémentaires par couleur et position

SP	0,43	0,40	0,35	0,30	0,21	0,21	0,21
LE	1,58	1,35	1,23	1,11	0,96	①	①

Les prix incluent une impression sur une position avec la technique indiquée.

① Prix sur demande.

Mode d'écriture :



Techniques d'impression :



(SP)
SÉRIGRAPHIE



(LE)
LASER

Emballage spécial en option :



Plastic Pouch / Window Box

+ INFO pag. 236 & 237

Emballage externe :



150 ± 2,5 Kg



FABRIQUÉ
EN ALLEMAGNE

www.bicgraphic.eu



GRIP ROLLER

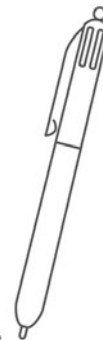

Profitez d'une expérience d'écriture fluide. Parfait pour les droitiers comme pour les gauchers, il glisse facilement sur le papier et ne fait pas de tâches grâce à son encre à séchage rapide.



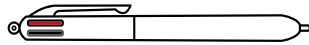

stylo roller à encre liquide, pointe moyenne pour une écriture fluide et agréable

BIC® GRIP ROLLER
1187



Commande minimale 250u.

Personnalisation :

BIC® GRIP ROLLER

1187

A/B SP : max. 3 col.

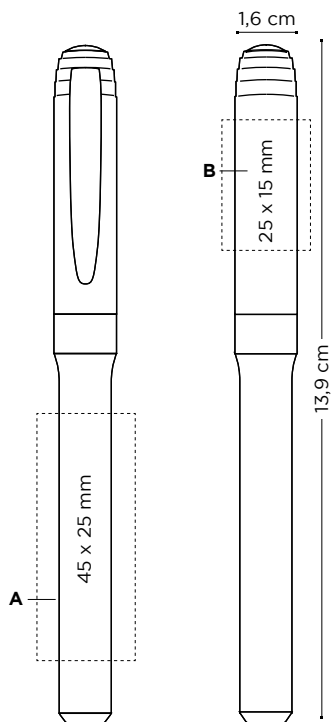

					Prix (€)
BIC® GRIP ROLLER	250-499	500-999	1000-2499	2500-4999	5000
1187					
SP	1,73	1,56	1,45	1,35	1,27

Frais d'impression supplémentaires par couleur et position

SP	0,16	0,13	0,13	0,13	0,12
-----------	------	------	------	------	------

Les prix incluent la sérigraphie sur un emplacement.

Mode d'écriture :

Roller



R
Ø0,7mm

Techniques d'impression :



(SP)
SÉRIGRAPHIE

Emballage spécial en option :



ECO Sleeve / Plastic Pouch / Window Box / Marking Set

+ INFO pag. 236 & 237

Emballage externe :



250 ± 3 Kg



www.bicgraphic.eu

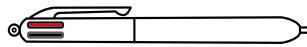

1851 Opaque

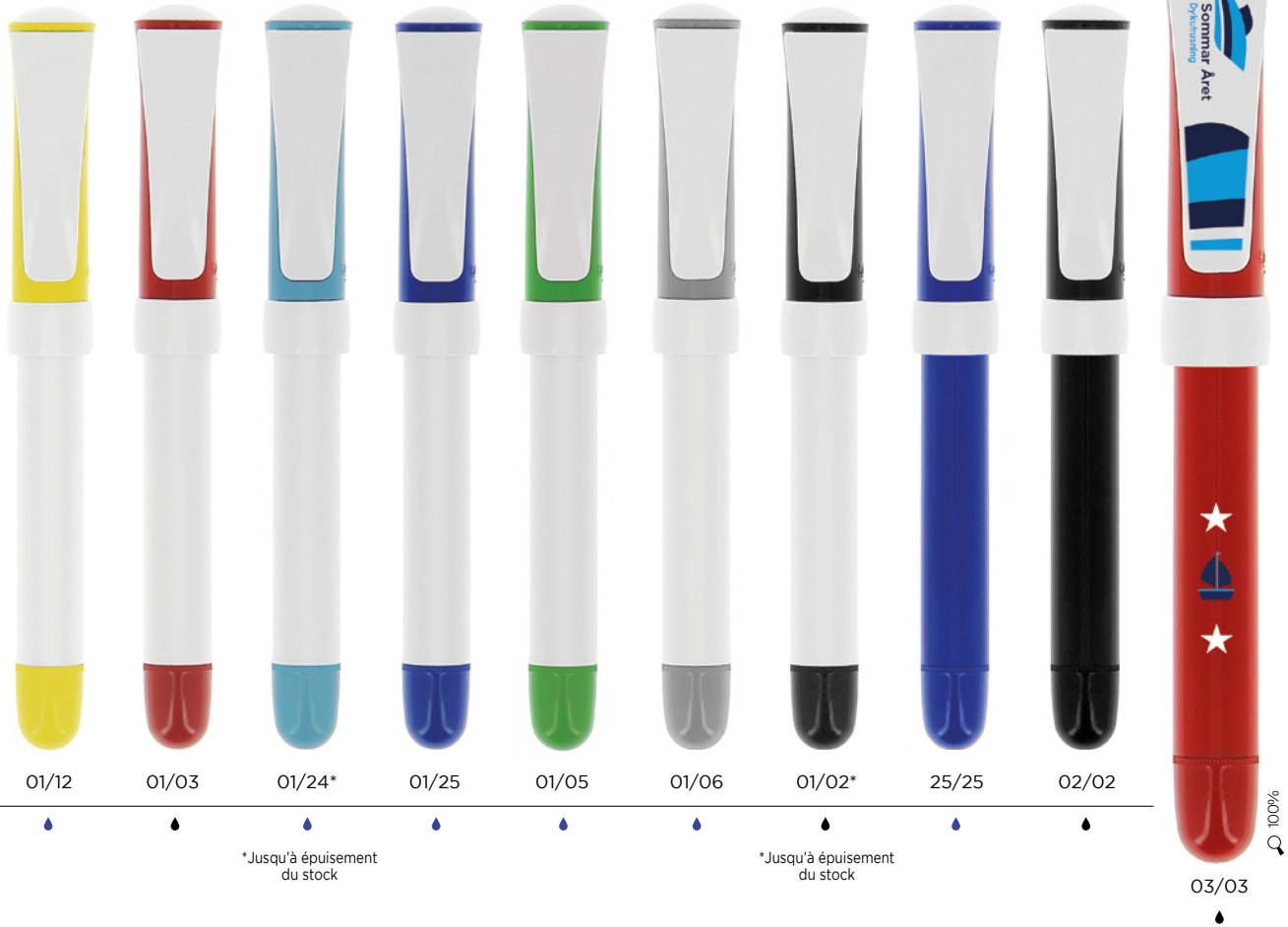

01/12

01/03

01/24*

01/25

01/05

01/06

01/02*

25/25

02/02

03/03

Couleur d'encre

*Jusqu'à épuisement du stock

*Jusqu'à épuisement du stock

100%

Commande minimale 250u.

Personnalisation :

BIC® XS FINESTYLE

1851

A PD : max. 2 col.

B SP : max. 2 col.

C DG : Numérique

1851
Opaque /
Transparent

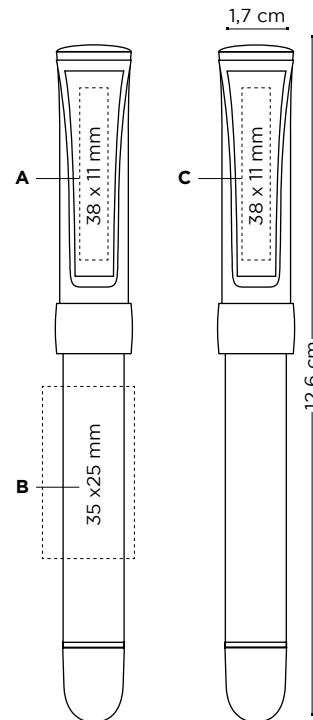

	Prix (€)				
BIC® XS FINESTYLE	250-499	500-999	1000-2499	2500-4999	5000
1851					
SP/PD	1,74	1,59	1,49	1,39	1,29
DG	1,98	1,81	1,69	1,58	1,47

Frais d'impression supplémentaires par couleur et position

SP/PD	0,16	0,13	0,13	0,13	0,12
DG Texture	0,17	0,15	0,14	0,14	0,13

Les prix incluent une impression sur une position avec la technique indiquée.

Injection d'une couleur spéciale :

≥ 10.000 unités

Mode d'écriture :

Pointe fine



FS
Ø0,7mm

Techniques d'impression :



(SP)
SÉRIGRAPHIE



(PD)
TAMOGRAPHIE



(DG) britePix™



Emballage spécial en option :



ECO Sleeve / Plastic Pouch

+ INFO pag. 236 & 237

Emballage externe :



250 ± 2,8 Kg



FABRIQUÉ EN ESPAGNE

www.bicgraphic.eu

121

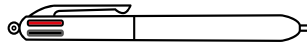

1196 Opaque



Picnique
BIC® Boy
est en relief



01

Couleur
d'encre



02



1196 Transparent



92



87



*Jusqu'à épuisement
du stock



88



86



93



Commande minimale 250u.

Personnalisation :

BIC® INTENSITY® GEL CLIC

1196

A SP : max. 2 col.

B SP : max. 4 col.

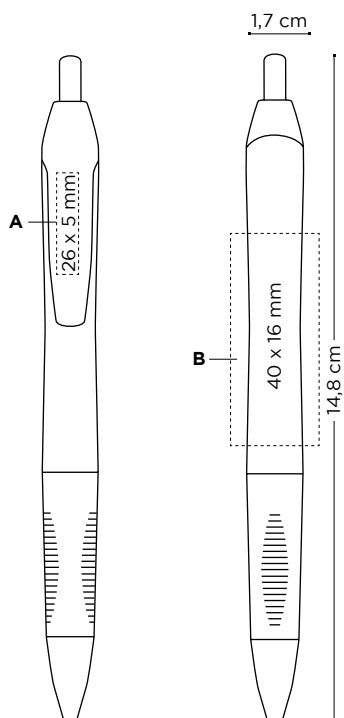

	250-499	500-999	1000-2499	2500-4999	Prix (€)
BIC® INTENSITY® GEL CLIC					5000
1196					
SP	2,75	2,49	2,31	2,15	2,03

Frais d'impression supplémentaires par couleur et position

SP	0,16	0,13	0,13	0,13	0,12
-----------	------	------	------	------	------

Les prix incluent la sérigraphie sur un emplacement.

Mode d'écriture :

Gel



G
Ø0,7mm

Techniques d'impression :



(SP)
SÉRIGRAPHIE

Emballage spécial en option :



Plastic Pouch

+ INFO pag. 237

Emballage externe :



250 ± 3,7 Kg



BRITE LINER

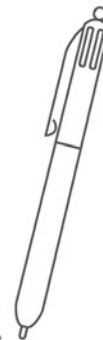

Donnez de l'impact à votre message, de la précision et du contrôle à votre écriture, grâce au grip en caoutchouc.

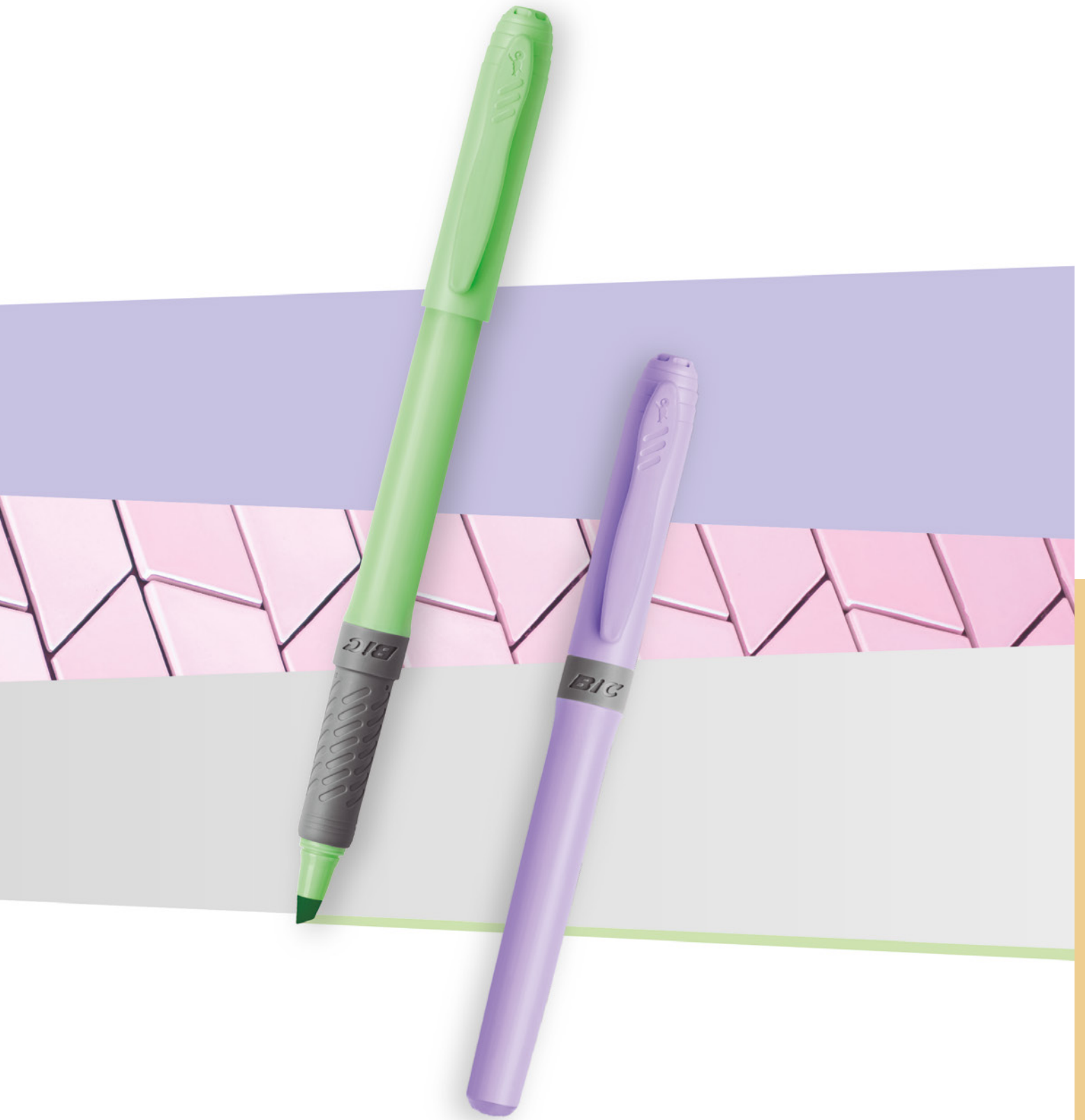

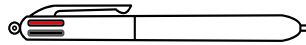

Convient pour le papier, les fax et les photocopies



1192

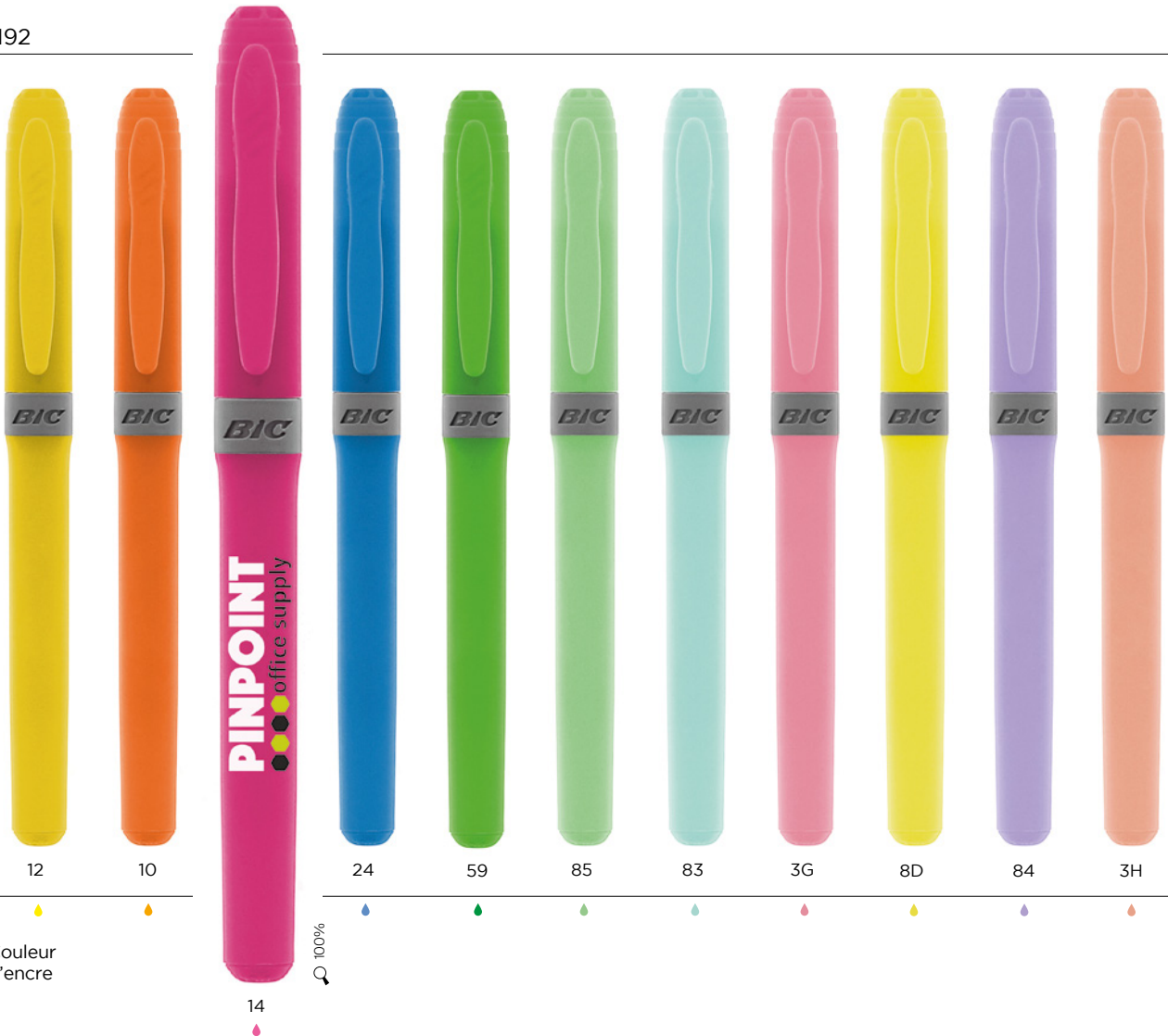

12

10

14

24

59

85

83

3G

8D

84

3H

Couleur d'encre

Q 100%

Commande minimale 250u.

Personnalisation :

BIC® BRITE LINER® GRIP
1192
A/B SP : max. 3 col.

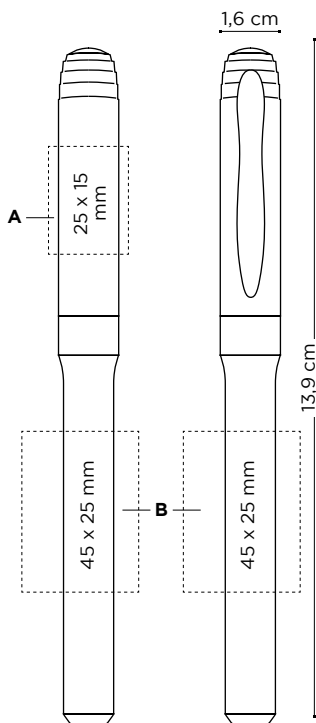

	250-499	500-999	1000-2499	2500-4999	Prix (€)
BIC® BRITE LINER® GRIP					5000
1192					
SP	1,55	1,43	1,31	1,22	1,14

Frais d'impression supplémentaires par couleur et position					
SP	0,16	0,13	0,13	0,13	0,12

Les prix incluent la sérigraphie sur un emplacement.

Mode d'écriture :

Highlighter



HL

Techniques d'impression :



(SP)
SÉRIGRAPHIE

Maintenant disponible en set!

Emballage spécial en option :



Marking Set
+ INFO pag. 237

Emballage externe :



250 ± 2,8 Kg



MARQUEURS

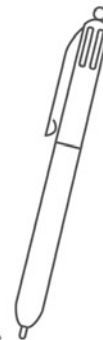

Les marqueurs BIC® sont des produits spécifiquement conçus pour écrire lisiblement sur des surfaces ou des matériaux sur lesquels d'autres instruments d'écriture ne peuvent être utilisés. Donnez de la visibilité à vos idées et exprimez-vous sur n'importe quelle surface avec les marqueurs BIC®.



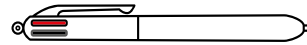

1651



01/03



01/04



01/05



01/02

Couleur d'encre



100%

Commande minimale 500u.

Personnalisation :

BIC® *Velleda* WHITE BOARD MARKER FINE
1651
A SP : max. 1 col.

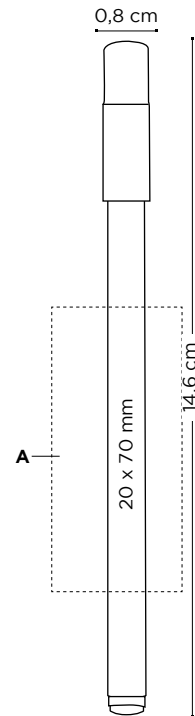

BIC® <i>Velleda</i> WHITE BOARD MARKER FINE 1651	250-499	500-999	1000-2499	2500-4999	5000
SP	-	0,56	0,50	0,47	0,44

Les prix incluent la sérigraphie sur un emplacement.

Mode d'écriture :

Marqueur



MK

Techniques d'impression :



(SP)
SÉRIGRAPHIE

Maintenant disponible en set!

Emballage spécial en option :



Marking Set
+ INFO pag. 237

Emballage externe :



500 ± 3,2 Kg



FABRIQUÉ EN FRANCE

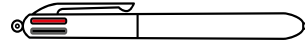

1213



Couleur d'encre

01/03

01/05

01/04

01/02

100%

Commande minimale 250u.

Personnalisation :

BIC® *Velleda* WHITE BOARD MARKER GRIP 1213
A/B SP : max. 3 col.

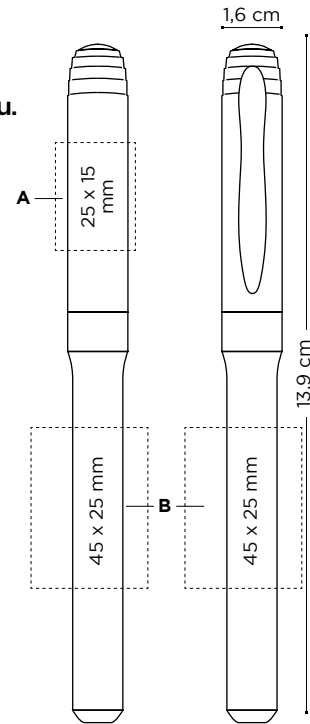

BIC® *Velleda* WHITE BOARD MARKER GRIP

1213

SP	250-499	500-999	1000-2499	2500-4999	5000
	1,52	1,37	1,27	1,18	1,11

Frais d'impression supplémentaires par couleur et position

SP	0,16	0,13	0,13	0,13	0,12
----	------	------	------	------	------

Les prix incluent la sérigraphie sur un emplacement.

Prix (€)

Mode d'écriture :

Marqueur pour ardoise blanche



MK

Techniques d'impression :



(SP) SÉRIGRAPHIE

Maintenant disponible en set!

Emballage spécial en option :



Marking Set
+ INFO pag. 237

Emballage externe :



250 ± 2,7 Kg

www.bicgraphic.eu

131

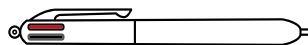

1214



01/03

01/05

01/02

Couleur d'encre



100%

01/04

Commande minimale 250u.

Personnalisation :

BIC® MARK-IT PERMANENT MARKER
1214

A/B SP : max. 3 col.

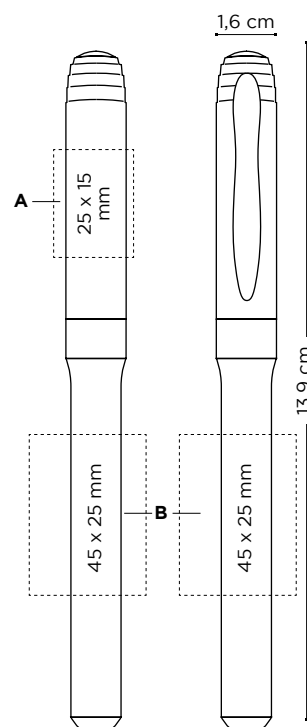

BIC® MARK-IT PERMANENT MARKER

1214

SP

250-499 500-999 1000-2499 2500-4999 5000

Prix (€)

1,49	1,34	1,25	1,16	1,09
------	------	------	------	------

Frais d'impression supplémentaires par couleur et position

SP 0,16 0,13 0,13 0,13 0,12

Les prix incluent la sérigraphie sur un emplacement.

Mode d'écriture :

Marqueur



MK

Techniques d'impression :



(SP) SÉRIGRAPHIE

Maintenant disponible en set!

Emballage spécial en option :



Marking Set
+ INFO pag. 237

Emballage externe :



250 ± 2,8 Kg

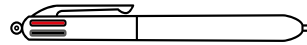

FABRIQUÉ À PARTIR DE 51% DE MATÉRIEL* RECYCLÉ ET EST **100% RECYCLABLE**



Ajoutez la boucle mobius sur votre BAT sans frais additionnels. Merci de le préciser dans votre bon de commande (en bas à gauche par défaut)

1210



Couleur d'encre

02

100%

02

Commande minimale 250u.

Personnalisation :

BIC® PERMANENT MARKER ecolutions®

1210

A SP : max. 1 col.

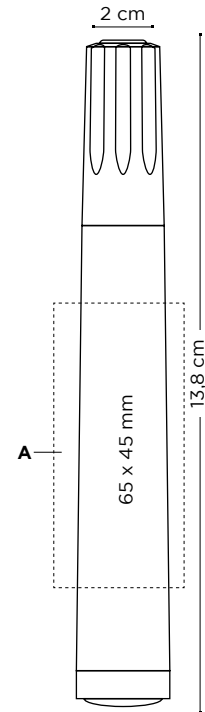

ecolutions® Fabriqué avec 51% de matériaux recyclés.

	Prix (€)				
BIC® PERMANENT MARKER ecolutions®	250-499	500-999	1000-2499	2500-4999	5000
1210					
SP	1,76	1,61	1,48	1,39	1,30

Les prix incluent la sérigraphie sur un emplacement.

Mode d'écriture :

Marqueur



MK

Techniques d'impression :



(SP)
SÉRIGRAPHIE

Emballage externe :



250 ± 2,6 Kg



FABRIQUÉ EN FRANCE

*Le pourcentage est calculé sur le poids total du produit hors cartouche



BIC® MATIC

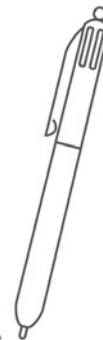

Toujours prêt avec ce porte-mine de grande qualité. Il est solide et la mine est résistante. Il n'a pas besoin d'être taillé et offre une écriture plus fluide et plus intense que jamais !

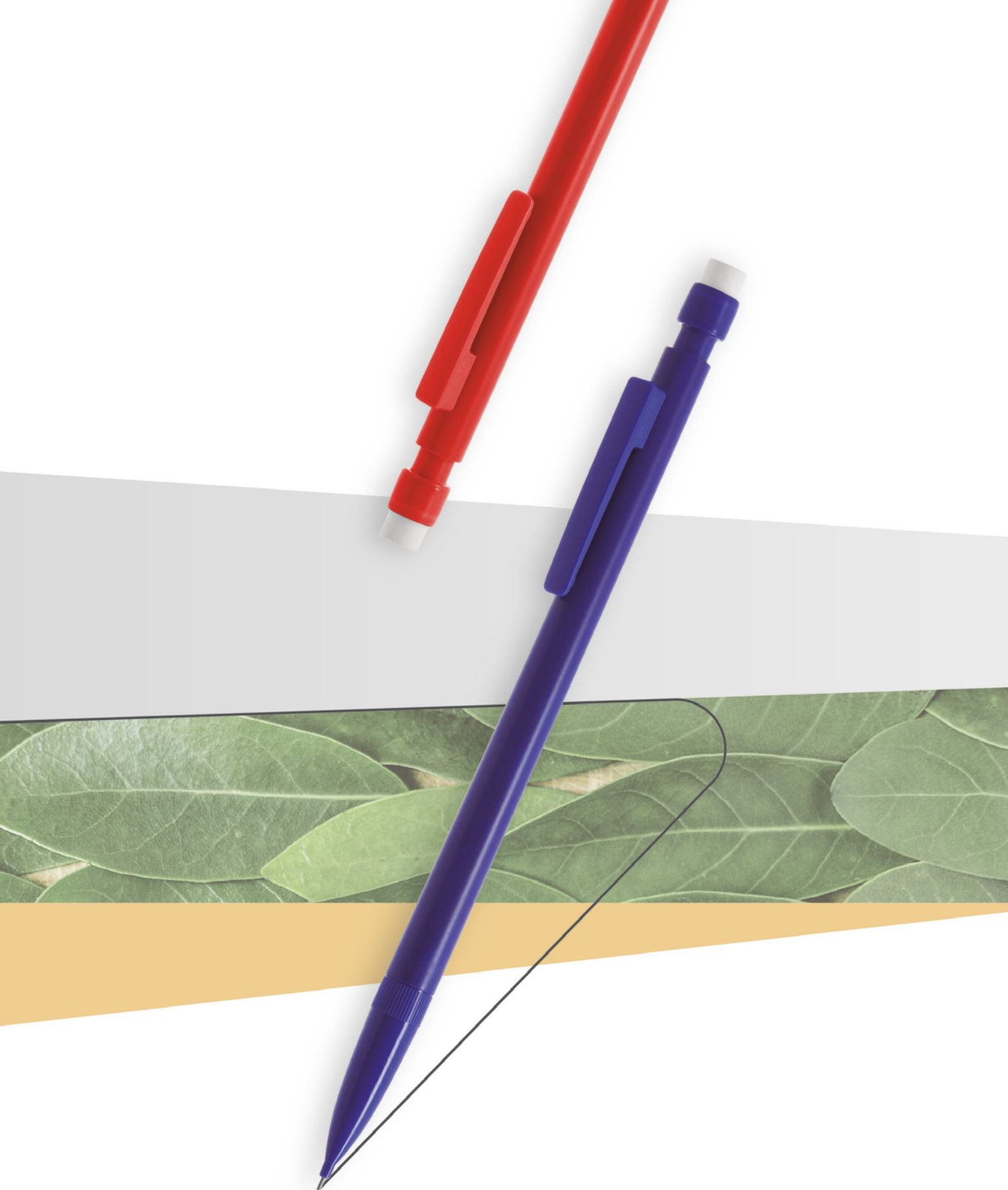

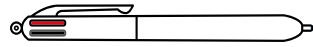

BIC® MATIC®
1120 Opaque



01/12

01/05

01/04

01/02

100%
01/03



ecolutions®



FABRIQUÉ À PARTIR DE 65%
DE MATÉRIEL* RECYCLÉ
ET EST 100% RECYCLABLE

Fabriqué à
partir de déchets
pharmaceutiques



BIC® MATIC®

ecolutions®

1E40 Opaque



01/01



12/12



03/03



59/8C*



04/8C*



07/07



06/8C*



02/02

*Jusqu'à épuisement du stock

**Pourcentage calculé sur le poids
total du produit



Ajoutez la boucle mobius sur votre BAT
sans frais additionnels. Merci de le préciser
dans votre bon de commande (en bas à
gauche par défaut)

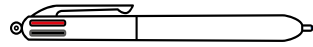

BIC® MATIC® QUARTZ
1121 Opaque



51/01*

*Jusqu'à épuisement du stock

BIC® MATIC® QUARTZ
QUARTZ METALLIC



51/18



51/07* 

BIC® MATIC® GRIP
1122 Opaque



01/04*



01/02*

Jusqu'à épuisement du stock

BIC® MATIC® GRIP
METALLIC



02/02 



1D/02*

Commande minimale 500u.

Personnalisation :

BIC® MATIC®
1120
@Colutions® 1E40

BIC® MATIC®
QUARTZ & METALLIC
1121

A SP : max. 1 col.
(non disponible pour
BIC® Matic® Quartz)
B/C SP : max. 2 col.

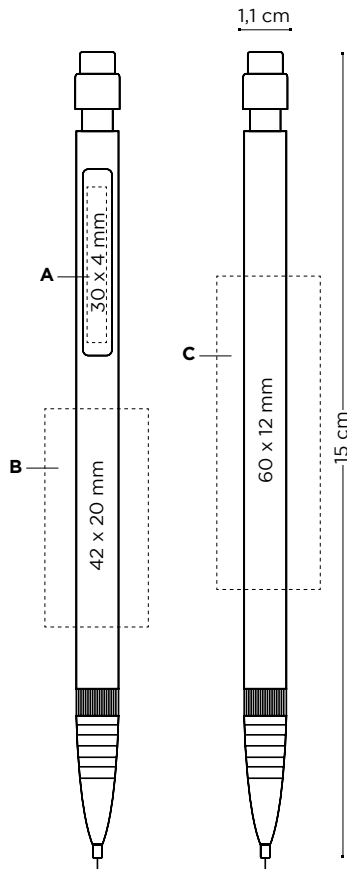

BIC® MATIC® GRIP & METALLIC
1122
A SP : max. 1 col.
B/C SP : max. 2 col.

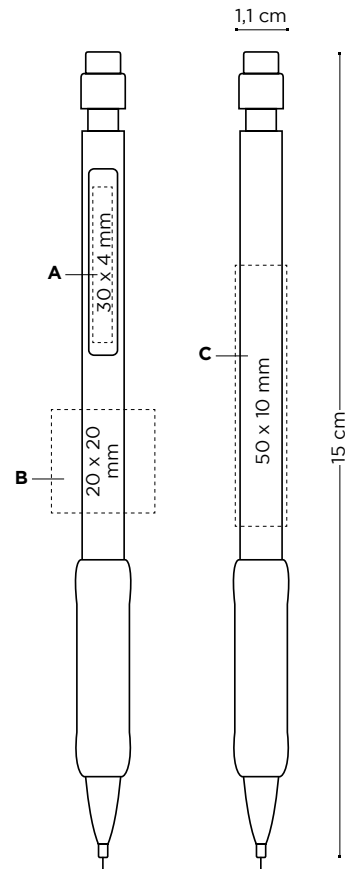

Version @Colutions® et
version STD au même prix !



	Prix (€)			
BIC® MATIC® QUARTZ & METALLIC	500-999	1000-2499	2500-4999	5000
1120/@Colutions® 1E40				
SP	0,77	0,72	0,67	0,63
1121				
SP	0,84	0,77	0,72	0,68

Frais d'impression supplémentaires par couleur et position

SP	0,13	0,13	0,13	0,12
-----------	------	------	------	------

Les prix incluent la sérigraphie sur un emplacement.

	Prix (€)			
BIC® MATIC® GRIP & METALLIC	500-999	1000-2499	2500-4999	5000
1122				
SP	0,92	0,86	0,81	0,75

Frais d'impression supplémentaires par couleur et position

SP	0,13	0,13	0,13	0,12
-----------	------	------	------	------

Les prix incluent la sérigraphie sur un emplacement.

Mode d'écriture :

porte-mine



MP
Ø0,7mm

Techniques d'impression :



(SP)
SÉRIGRAPHIE

Emballage spécial en option :



Plastic Pouch
+ INFO pag. 237

Emballage externe :



500 ± 3,1 Kg



FABRIQUÉ
EN FRANCE

 **EVOLUTION**® **ecolutions**®

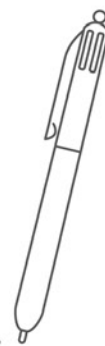

Crayon papier en résine synthétique, sans bois, qui ne fait pas d'écharde en cas de casse. Mine graphite HB ultrarésistante qui s'efface facilement !



Instruments d'écriture BIC® • CRAYONS

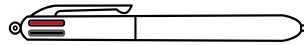

FABRIQUÉ À PARTIR DE 54% DE MATÉRIEL* RECYCLÉ ET EST **100% RECYCLABLE**



FABRIQUÉ À PARTIR DE 46% DE MATÉRIEL* RECYCLÉ ET EST **100% RECYCLABLE**

Fabriqué à partir de réfrigérateurs recyclés et de pots de yaourts usagés

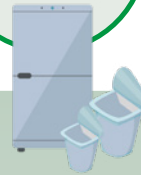

1150
Crayon avec bout coupé

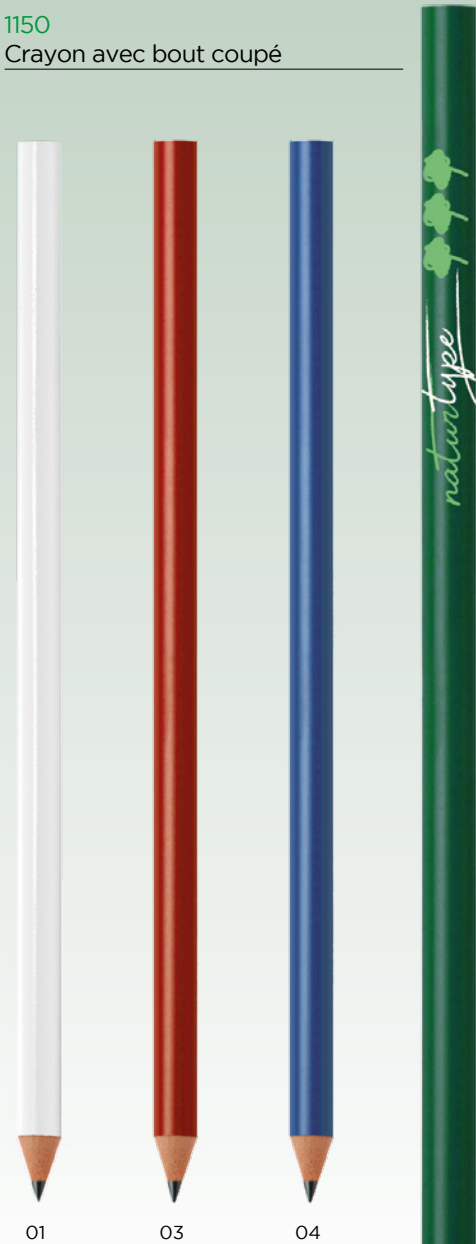

01

03

04

20



1151
Crayon Avec Gomme



02

01

03

04

02

20



l'icône BIC[®] Boy est en relief



*Pourcentage calculé sur le poids total du produit

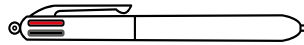

La solution pour une **communication toute en couleur !**



1150

FABRIQUÉ À PARTIR DE 54% DE MATÉRIEL* RECYCLÉ ET EST **100% RECYCLABLE**



1151

FABRIQUÉ À PARTIR DE 46% DE MATÉRIEL* RECYCLÉ ET EST **100% RECYCLABLE**

Fabriqué à partir de réfrigérateurs recyclés et de pots de yaourts usagés



DIGITAL 1150
Crayon avec bout coupé

favorite

DIGITAL 1151
Crayon avec gomme

weltimport

l'icône BIC® Boy est en relief



01



01

Commande minimale 500u.

MIX &
MATCH



Combinaison de couleurs standards

Gomme

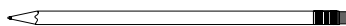

OPAQUE 01 COULEUR CONNECTION 01 12* 10 59* 07* 02

*Jusqu'à épuisement du stock

Virole



OPAQUE 47 26 2C* 34* 02

*Jusqu'à épuisement du stock

Corps



OPAQUE 01 03 04 20 02

Crayon avec bout coupé

FABRIQUÉ À PARTIR
DE 54% DE MATÉRIEL**
RECYCLÉ ET EST
100% RECYCLABLE



Ajoutez la boucle mobius sur votre BAT sans frais additionnels. Merci de le préciser dans votre bon de commande (en bas à gauche par défaut)

Mode d'écriture :



PC
HB Ø 2,3mm

Techniques d'impression :



(SP)
SÉRIGRAPHIE



(DG)
NUMÉRIQUE

Emballage spécial en option :



Plastic Pouch
(x3 units)
+ INFO pag. 237

Emballage externe :



500 ± 3,5 Kg



FABRIQUÉ
EN FRANCE

www.bicgraphic.eu

143

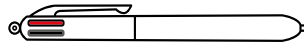

BIC® EVOLUTION® ecolutions®
 CRAYON AVEC BOUT COUPÉ
 1150

BIC® EVOLUTION® ecolutions®
 CRAYON AVEC GOMME
 1151

A SP : max. 2 col.
B SP : max. 1 col.

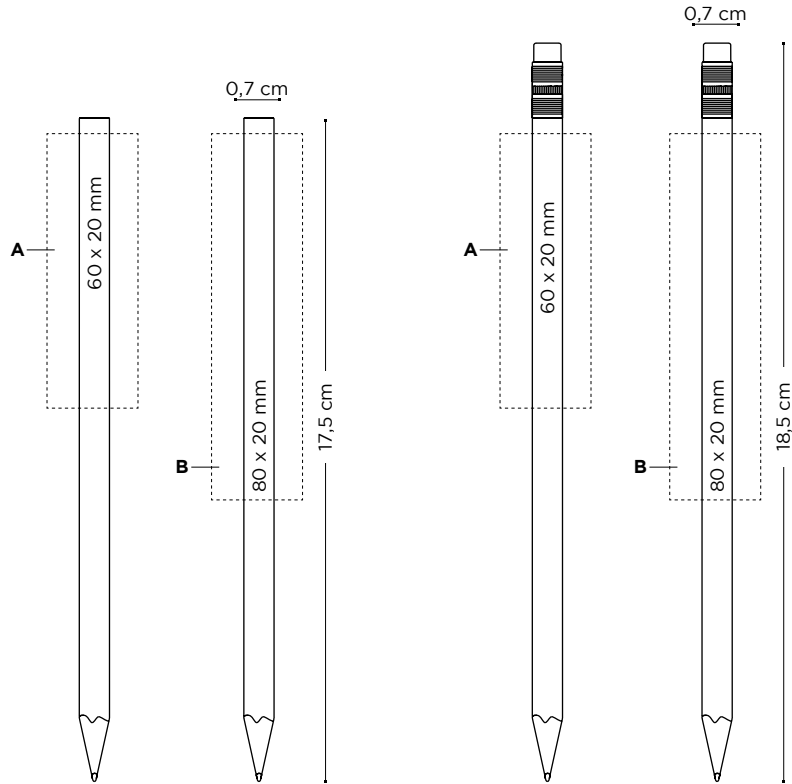

				Prix (€)
BIC® EVOLUTION® ecolutions®	500-999	1000-2499	2500-4999	5000
CRAYON AVEC BOUT COUPÉ / 1150				
SP	0,44	0,42	0,39	0,37
CRAYON AVEC GOMME / 1151				
SP	0,75	0,70	0,66	0,62

Frais d'impression supplémentaires par couleur et position

SP	0,13	0,13	0,13	0,12
-----------	------	------	------	------

Les prix incluent la sérigraphie sur un emplacement.

Emballage externe :



500 ± 3,5 Kg



FABRIQUÉ
 EN FRANCE

BIC® EVOLUTION® eColutions®
 CRAYON AVEC BOUT COUPÉ
 1150 Digital

BIC® EVOLUTION® eColutions®
 CRAYON AVEC GOMME
 1151 Digital

A DG : Numérique (zone image)
B DG : Numérique (zone texte)

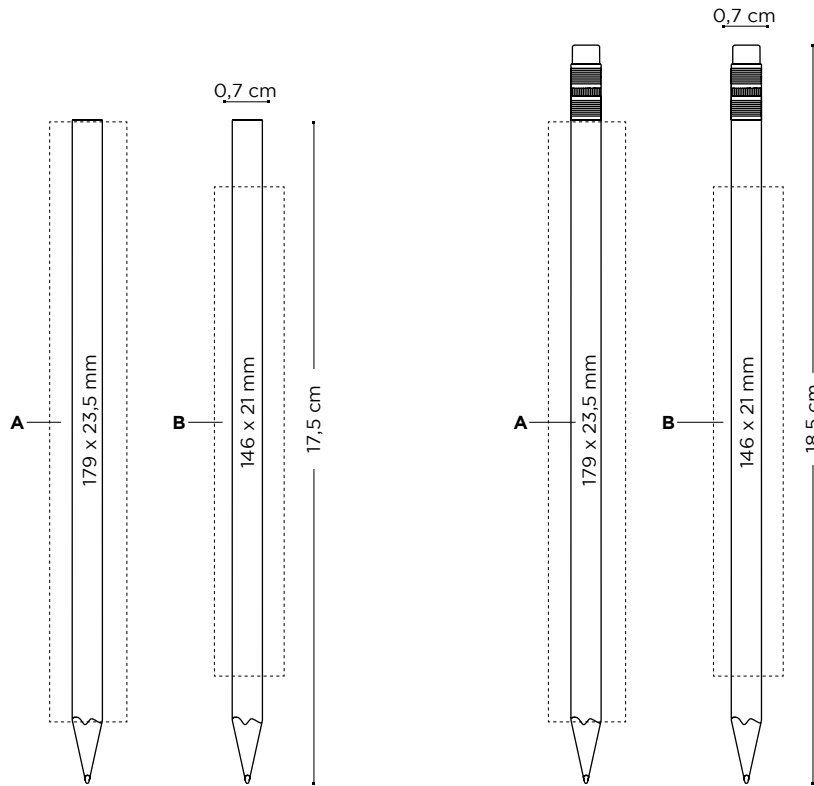

				Prix (€)
BIC® EVOLUTION® eColutions®	500-999	1000-2499	2500-4999	5000
CRAYON AVEC BOUT COUPÉ IMPRESSION NUMÉRIQUE / 1150				
DG	0,69	0,66	0,61	0,57
CRAYON AVEC GOMME IMPRESSION NUMÉRIQUE / 1151				
DG	1,00	0,94	0,88	0,82

Les prix incluent l'impression numérique sur le corps.

Maintenant disponible en set!

Emballage spécial en option :



Plastic Pouch
 (x3 unités)

+ INFO pag. 237

Emballage externe :



500 ± 3,5 Kg

1151
 1150



FABRIQUÉ
 EN FRANCE

www.bicgraphic.eu

145



Sprout

Les crayons Sprout personnalisables sont utilisés par les entreprises et les organisations du monde entier pour communiquer leur respect de l'environnement. Une fois que le crayon est trop court pour écrire, plantez-le et regardez votre message se transformer en superbe pot d'herbes aromatiques, de fleurs ou de légumes.



Choisissez entre **11** graines différentes



Épicéa

NOUVEAU



Tournesol



Pâquerette



Oeillet



Myosotis



Basilic



Thym



Sauge



Coriandre



Chia



Tomate
cerise



Sprout GRAPHITE PENCIL

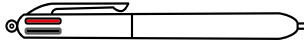

53062 Mine graphite



53070 Mine multicolore



NOUVEAU



Corps standard

Corps personnalisés

carton standard



Arrière

Emballage carton standard

carton personnalisable



Emballage carton personnalisé

80%

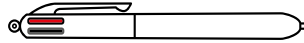

Commande minimale 500
Commande minimale 1000 (crayon + emballage carton personnalisé)

Personnalisation :

SPROUT™ PENCIL
 53062 / 53070
A LE
B DG : 4-colour process

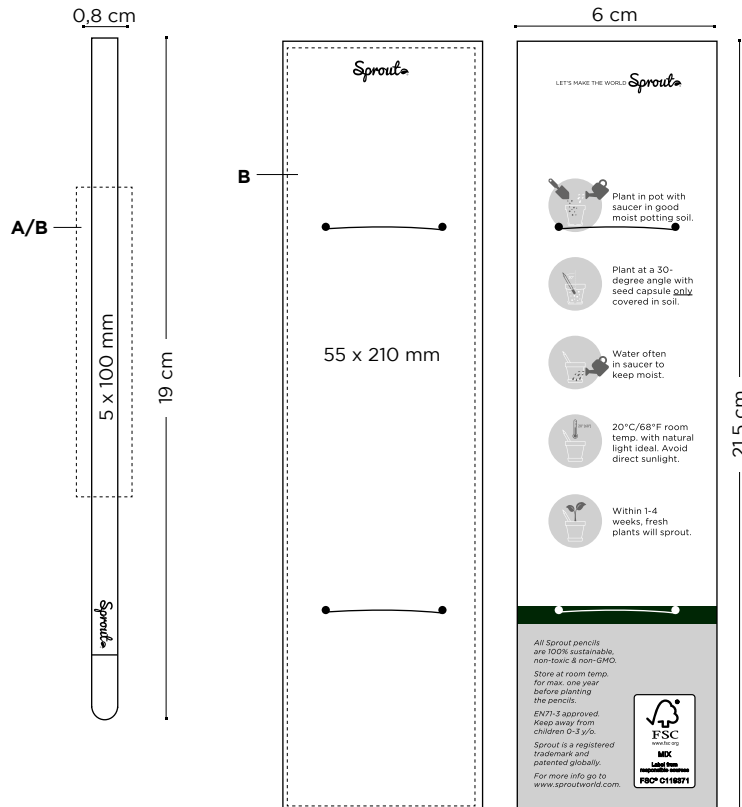

Mode d'emploi inclus au dos
 Pour un carton personnalisé, vous pouvez changer la police et les couleurs

Mode d'écriture :

Techniques d'impression :

Emballage externe :

Emballage :

Regardez la video



PC
 HB Ø 2,3mm



(DG)
 NUMÉRIQUE



(LE)
 LASER



500 ± 2,5 Kg Seulement crayon
 ± 5 Kg Avec emballage en carton





AUTRES INSTRUMENTS D'ÉCRITURE

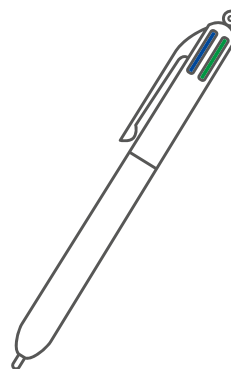

AUTRES INSTRUMENTS D'ÉCRITURE

STYLOS

Basic Pen	150
Click Pen	152
Striped Grip Pen	154
White Striped Grip Pen	154

STYLOS STYLUS

Sleek Stylus Pen	156
------------------	-----

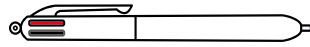

12010

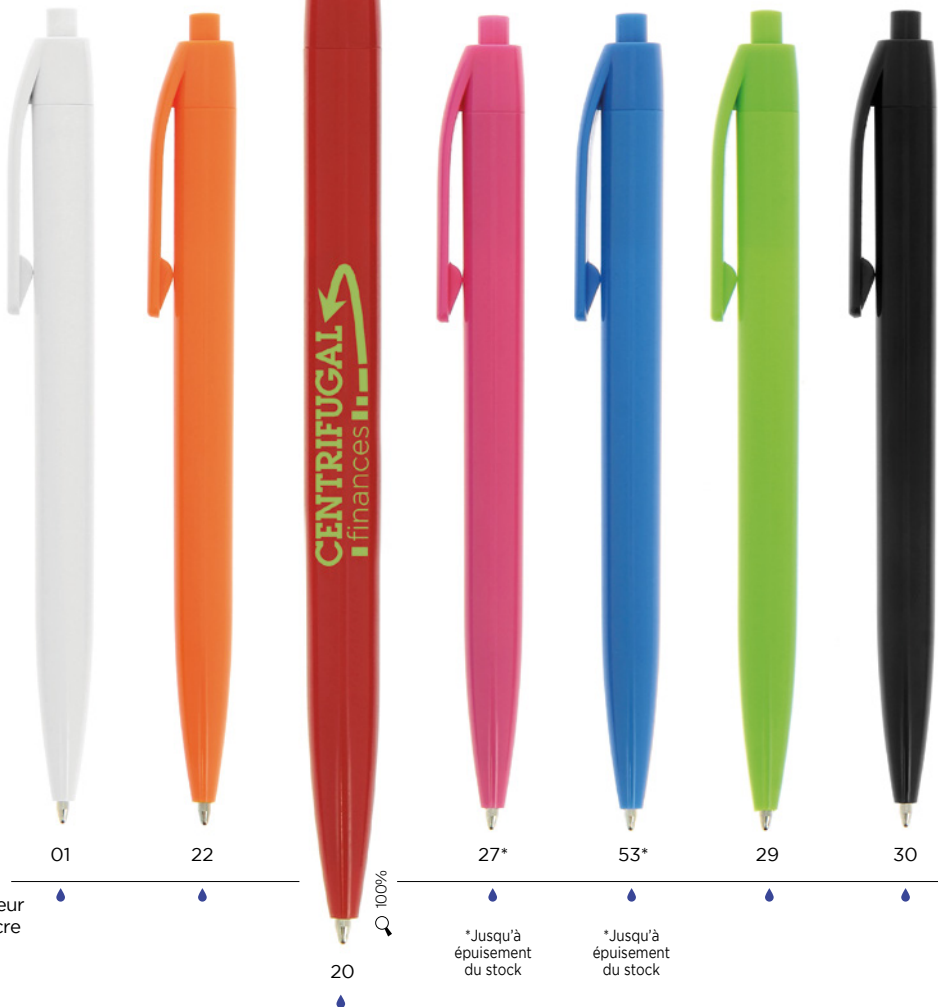

Commande minimale 500u.

Personnalisation :

BASIC PEN

12010

A/B SP : max. 1 col.

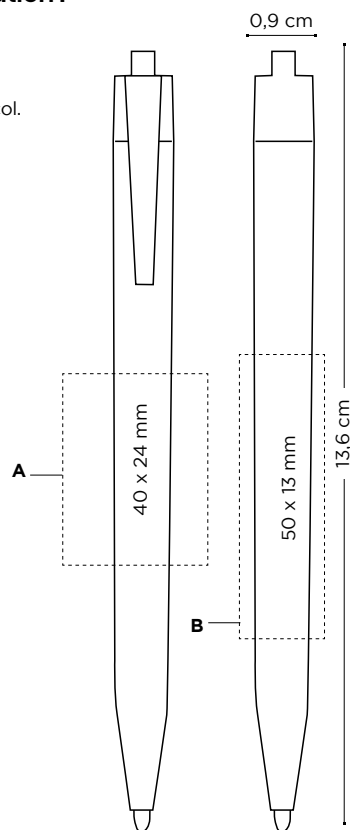

	Prix (€)			
BASIC PEN	500-999	1000-2499	2500-4999	5000
12010				
Neutre	0,15	0,14	0,14	0,13
SP	0,51	0,40	0,34	0,31

Les prix incluent la sérigraphie sur un emplacement.

Mode d'écriture :



Techniques d'impression :



Emballage externe :



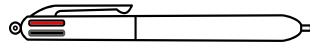

11748



10



23



22

100%



20



27*

*Jusqu'à épuisement du stock



25*

*Jusqu'à épuisement du stock



53



50



60



30

Couleur d'encre



Commande minimale 500u.

Personnalisation :

CLICK PEN

11748

A/B SP : max. 4 col.

C/D PD : max. 4 col.

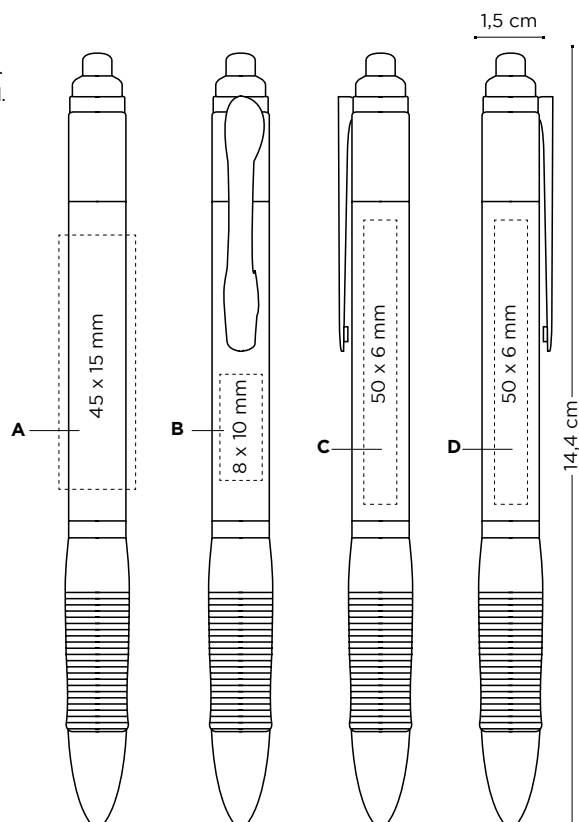

				Prix (€)
CLICK PEN	500-999	1000-2499	2500-4999	5000
11748				
Neutre	0,20	0,19	0,19	0,18
SP	0,56	0,45	0,39	0,36
PD	0,63	0,54	0,46	0,43

Coûts supplémentaires :

SP	0,13	0,13	0,13	0,12
PD	0,35	0,26	0,19	0,18

Les prix incluent une impression sur une position avec la technique indiquée.

Mode d'écriture :

Bille



M

Techniques d'impression :



(SP)
SÉRIGRAPHIE



(PD)
TAMPOGRAPHIE

Emballage externe :



1000 ± 9,5 Kg



STRIPED GRIP PEN & WHITE STRIPED GRIP PEN

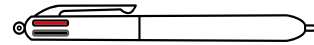

STRIPED GRIP PEN 11243



22 20 27 25 51

Couleur d'encre

50

100%

WHITE STRIPED GRIP PEN 11303



20 27* 50 25

*Jusqu'à épuisement du stock

100%

Autres instruments d'écriture • STYLOS

Commande minimale 500u.

Personnalisation :

STRIPED GRIP PEN

11243

WHITE STRIPED GRIP PEN

11303

A SP : max. 2 col.

B PD : max. 1 col.

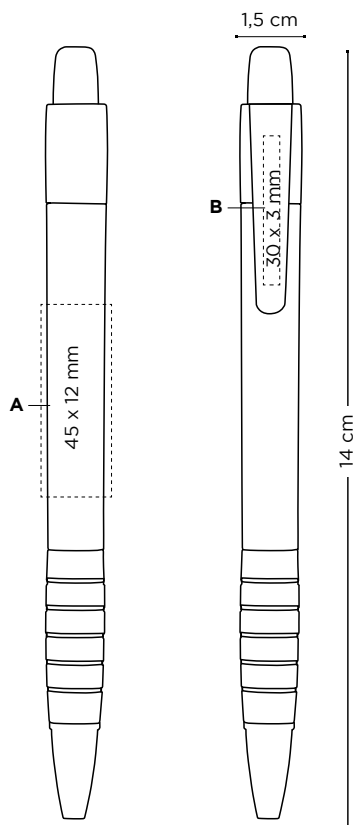

**STRIPED GRIP PEN &
 WHITE STRIPED GRIP PEN**

11243 / 11303

	500-999	1000-2499	2500-4999	Prix (€)
Neutre	0,30	0,29	0,29	0,27
SP	0,66	0,55	0,49	0,45
PD	0,73	0,64	0,56	0,52

Coûts supplémentaires :

SP	0,13	0,13	0,13	0,12
PD	0,35	0,26	0,19	0,18

Les prix incluent une impression sur une position avec la technique indiquée.

Mode d'écriture :



Techniques d'impression :



(SP)
SÉRIGRAPHIE



(PD)
TAMOGRAPHIE

Emballage externe :



1000 ± 9 Kg



SLEEK STYLUS PEN

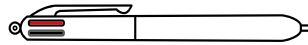

SLEEK STYLUS PEN

11666



Couleur d'encre

*Jusqu'à épuisement du stock

SLEEK STYLUS MATT PEN

11747



SLEEK STYLUS EXECUTIVE PEN

11976



Autres instruments d'écriture • STYLOS STYLUS

Commande minimale 100u. (LE)
 Commande minimale 500u. (SP)

Personnalisation :

SLEEK STYLUS PEN

11666

SLEEK STYLUS MATT PEN

11747

SLEEK STYLUS EXECUTIVE PEN

11976

A SP : max. 1 col.

B SP : max. 2 col.

C/D/E/F LE

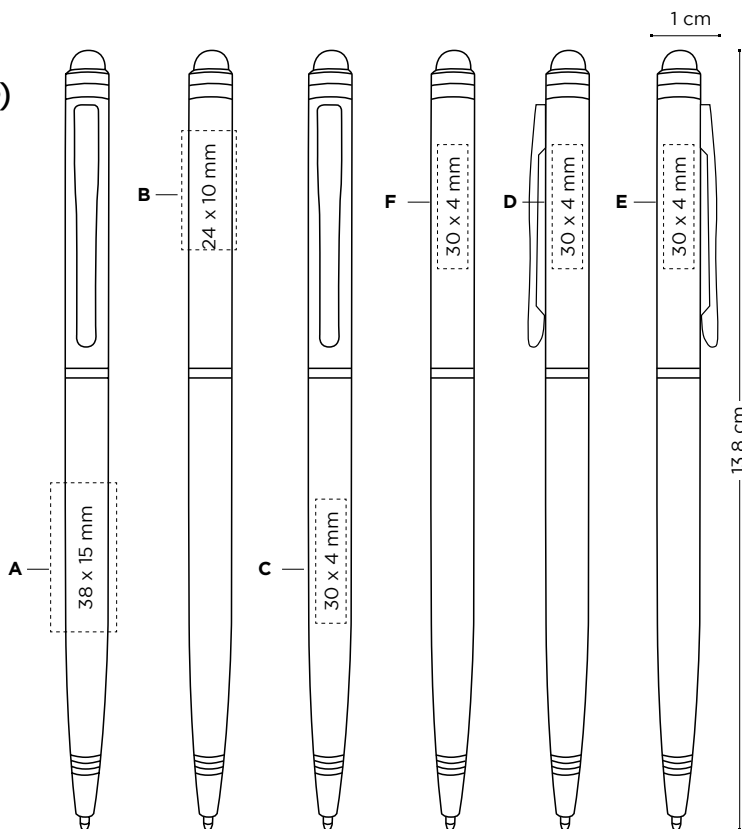

	Prix (€)					
	100-249	250-499	500-999	1000-2499	2500-4999	5000
SLEEK STYLUS PEN						
11666						
Neutre	1,79	1,72	1,66	1,59	1,59	1,49
SP	-	2,37	2,18	2,00	1,94	1,80
LE	3,66	3,10	2,85	2,68	2,65	2,52
11747 / 11976						
Neutre	1,92	1,84	1,76	1,69	1,69	1,59
SP	-	2,49	2,28	2,10	2,04	1,90
LE	3,79	3,22	2,95	2,78	2,75	2,62

Coûts supplémentaires :

SP	-	0,37	0,32	0,22	0,22	①
LE	1,82	1,34	1,16	1,06	1,03	1,00

Les prix incluent une impression sur une position avec la technique indiquée.

① Prix sur demande.

Mode d'écriture :

Bille



M

Gravure laser non disponible
 en couleur jaune / argent

Techniques d'impression :



(SP)
 SÉRIGRAPHIE



(LE) LASER

Emballage externe :



11666

900 ± 12,4 Kg



11747
 11976

800 ± 13 Kg

NOTES ADHESIVES

BIC®

BLOC-NOTES ADHÉSIFS

BIC® 50 mm x 75 mm Adhesive Notepads	162
BIC® 68 mm x 75 mm Adhesive Notepads	164
BIC® 75 mm x 75 mm Adhesive Notepads	166
BIC® 101 mm x 75 mm Adhesive Notepads & BIC® 101 mm x 75 mm Alternating Sheet Imprint	168
BIC® 101 mm x 101 mm Adhesive Notepads	170
BIC® 101 mm x 130 mm Adhesive Notepads	172
BIC® Small Adhesive Die Cut Notepad	174
BIC® Medium Adhesive Die Cut Notepads	176

BOOKLETS

BIC® 75 x 75 Booklet	180
BIC® 75 x 75 Adhesive Notepad With Flag Booklet	182
BIC® 101 x 75 Booklet	184
BIC® 150 x 150 mm Booklet Organiser	186
BIC® 150 x 150 mm Booklet With Pen Loop	188
BIC® Clic Stic Organiser & BIC® Clic Stic Mini Digital Organiser	190
BIC® Flag Booklet	194

SCRATCH PADS

BIC® 75 x 127 mm Non-Adhesive Scratch Pad	196
BIC® 96 x 152 mm Non-Adhesive Scratch Pad	197



NOTES ADHESIVES

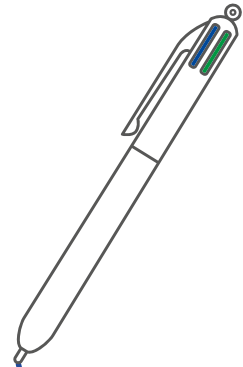



STICKY NOTES **ecolutions**[®]

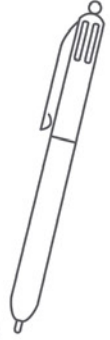

Les Sticky Notes BIC[®], l'outil indispensable dans votre bureau. Choisissez entre plusieurs formes et dimensions disponibles, adhésives ou non.

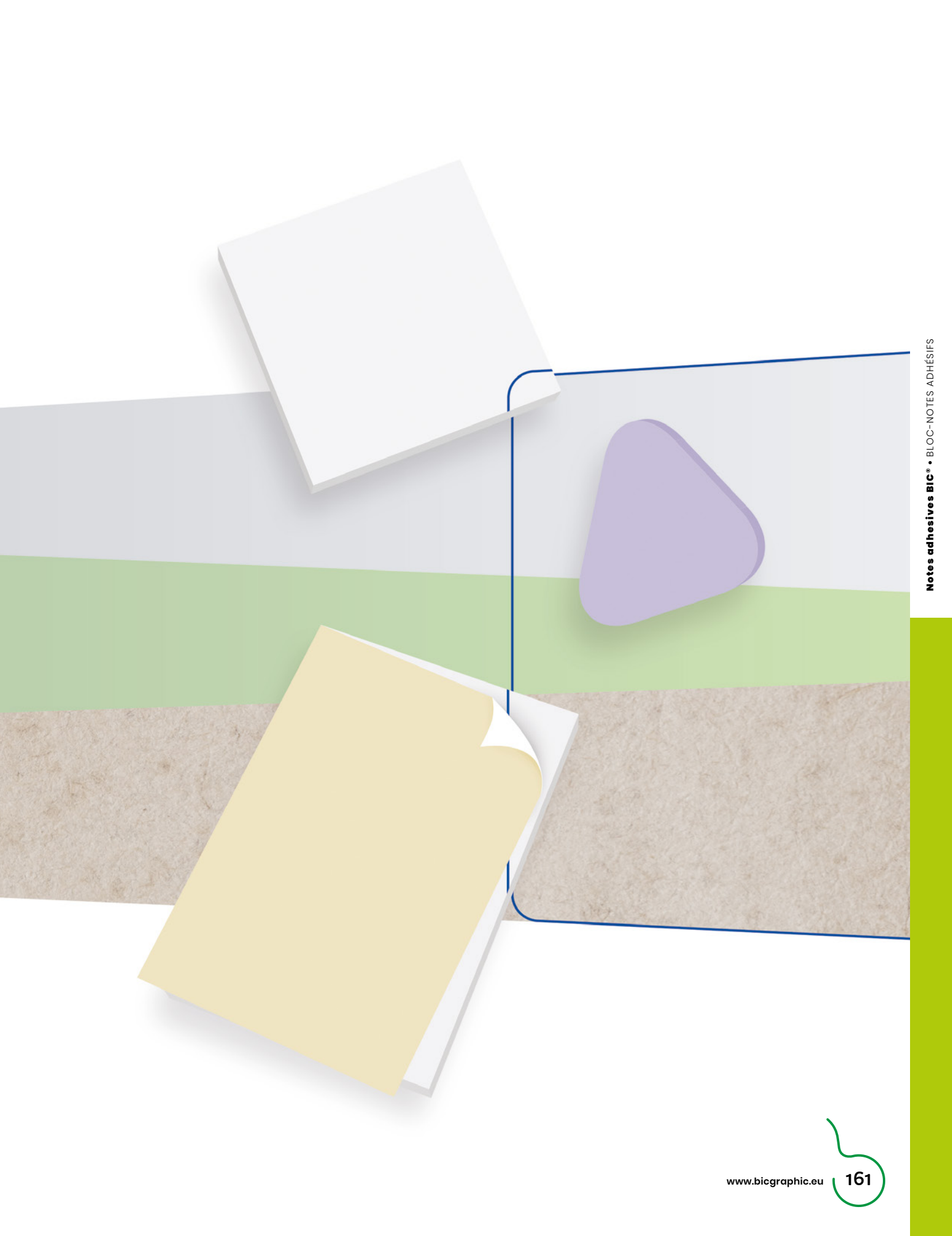



50 MM X 75 MM ADHESIVE NOTEPADS **ECOolutions®**

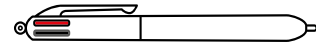

FABRIQUÉ À PARTIR DE 100% DE FIBRE RECYCLÉE* ET 100% RECYCLABLE



Dimension idéale pour les notes en entreprise !

Notes adhesives BIC® • BLOC-NOTES ADHÉSIFS

Marquage d'une couleur spécifique :

≥ 500 unités

Type de papier :

Recyclé 80g

Emballage spécial :
Emballage sous film plastique

N° de feuilles	Unités par pack
25	10
50	5

Techniques d'impression :



(DG)
NUMÉRIQUE



FABRIQUÉ EN ESPAGNE



Personnalisation : **Commande minimale 500u.**

**BIC® 50 MM X 75 MM
ADHESIVE NOTEPADS
A DG: Numérique**

 25 **ecolutions® 3520**

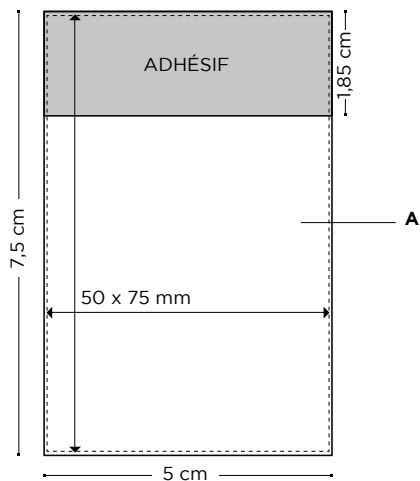
 50 **ecolutions® 3550**



		Prix (€)				
BIC® 50 MM X 75 MM ADHESIVE NOTEPADS		250-499	500-999	1000-2499	2500-4999	5000
 25	ecolutions® 3520					
	DG	-	0,47	0,39	0,26	0,22
 50	ecolutions® 3550					
	DG	-	0,78	0,59	0,39	0,33

Coûts supplémentaires :

Marquage d'une couleur spécifique sur les feuilles 105€

Les prix incluent l'impression en quadrichromie.

Les commandes doivent être un multiple de la quantité minimum indiquée.
Coût additionnel pour emballage sous film : 0,11€

Emballage externe :



 25

1000 ± 8,7 Kg



 50

500 ± 8,5 Kg

*Pourcentage calculé sans la dernière page



68 MM X 75 MM ADHESIVE NOTEPADS **ecolutions**

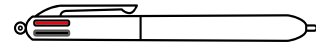

FABRIQUÉ À PARTIR DE 100% DE FIBRE RECYCLÉE* ET 100% RECYCLABLE



130%



Bloc-notes sticky Notes idéaux pour toujours emporter vos messages avec vous !

Marquage d'une couleur spécifique :

≥ 500 unités

Type de papier :

Recyclé 80g

Emballage spécial :
Emballage sous film plastique

N° de feuilles	Unités par pack
25	10
50	5

Techniques d'impression :



(DG)
NUMÉRIQUE



FABRIQUÉ EN ESPAGNE



Personnalisation : **Commande minimale 500u.**

**BIC® 68 MM X 75 MM
ADHESIVE NOTEPADS
A DG: Numérique**

 25 @ccolutions® 3500

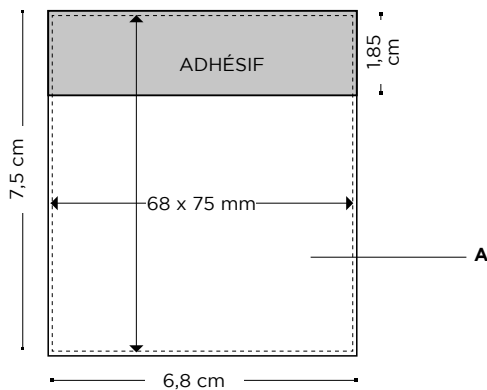
 50 @ccolutions® 3530



		Prix (€)				
BIC® 68 MM X 75 MM ADHESIVE NOTEPADS		250-499	500-999	1000-2499	2500-4999	5000
 25	@ccolutions® 3500					
	DG	-	0,56	0,46	0,30	0,24
 50	@ccolutions® 3530					
	DG	-	0,85	0,63	0,46	0,37

Coûts supplémentaires :

Marquage d'une couleur spécifique sur les feuilles

105€

Les prix incluent l'impression en quadrichromie.

Les commandes doivent être un multiple de la quantité minimum indiquée.
Coût additionnel pour emballage sous film : 0,11€

Emballage externe :

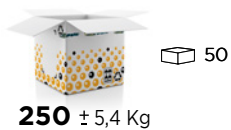
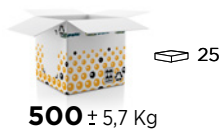

*Pourcentage calculé sans la dernière page



75 MM X 75 MM ADHESIVE NOTEPADS

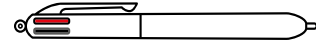

FABRIQUÉ À PARTIR DE 100% DE FIBRE RECYCLÉE* ET 100% RECYCLABLE



130%



Grande zone d'impression avec une taille mini !

Notes adhesives BIC® • BLOC-NOTES ADHÉSIFS

Marquage d'une couleur spécifique :

≥ 500 unités

Type de papier :

Recyclé 80g

Emballage spécial :
Emballage sous film plastique

N° de feuilles	Unités par pack
25	10
50	5

Techniques d'impression :



(DG)
NUMÉRIQUE



FABRIQUÉ EN ESPAGNE

Personnalisation : **Commande minimale 500u.**





**BIC® 75 MM X 75 MM
ADHESIVE NOTEPADS**

A DG: Numérique

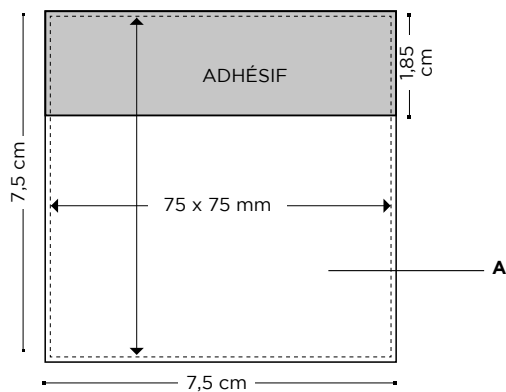
 25  **3505**

 50  **3535**



		Prix (€)				
		250-499	500-999	1000-2499	2500-4999	5000
 25	 3505					
	DG	-	0,59	0,48	0,33	0,26
 50	 3535					
	DG	-	0,87	0,65	0,48	0,41

Coûts supplémentaires :

Marquage d'une couleur spécifique sur les feuilles

105€

Les prix incluent l'impression en quadrichromie.

Les commandes doivent être un multiple de la quantité minimum indiquée.
Coût additionnel pour emballage sous film : 0,11€

Emballage externe :



 25

500 ± 6,2 Kg



 50

250 ± 5,9 Kg

*Pourcentage calculé sans la dernière page



101 MM X 75 MM ADHESIVE NOTEPADS *ecolutions*[®]
& BIC[®] 101 MM X 75 MM ALTERNATING SHEET IMPRINT *ecolutions*[®]

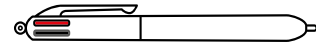

FABRIQUÉ À PARTIR DE 100% DE FIBRE RECYCLÉE* ET **100% RECYCLABLE**



Indispensable dans
n'importe quel bureau !
Le sticky notes de la taille
la plus populaire !



100%



Alternez 2 messages pour un double impact !

Notes adhesives BIC® • BLOC-NOTES ADHÉSIFS

Marquage d'une couleur spécifique :

≥ 500 unités

Type de papier :

Recyclé 80g

**Emballage spécial :
Emballage sous film
plastique**

N° de feuilles	Unités par pack
25	10
50	5

**Techniques
d'impression :**



(DG)
NUMÉRIQUE



FABRIQUÉ EN
ESPAGNE

Personnalisation :

BIC® 101 MM X 75 MM ADHESIVE NOTEPADS & ALTERNATING SHEET IMPRINT

A DG: Numérique

 25  **Commande minimale 500u.**



 Alternating Sheet 3519

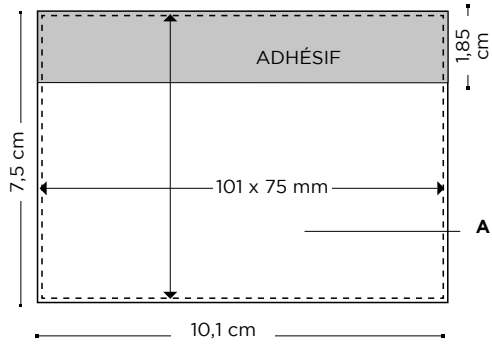

 50  **Commande minimale 250u.**

 Alternating Sheet 3549



		Prix (€)				
BIC® 101 MM X 75 MM ADHESIVE NOTEPADS & ALTERNATING SHEET		250-499	500-999	1000-2499	2500-4999	5000

 25	 3510					
	DG	-	0,70	0,54	0,41	0,33
	 Alternating Sheet 3519					
	DG	-	0,70	0,54	0,41	0,33

 50	 3540					
	DG	1,13	0,96	0,80	0,59	0,52
	 Alternating Sheet 3549					
	DG	1,13	0,96	0,80	0,59	0,52

Coûts supplémentaires :

Marquage d'une couleur spécifique sur les feuilles

105€

Les prix incluent l'impression en quadrichromie.

Les commandes doivent être un multiple de la quantité minimum indiquée.
Coût additionnel pour emballage sous film : 0,11€

Emballage externe :



 25

500 ± 8,2 Kg



 50

250 ± 8 Kg

*Pourcentage calculé sans la dernière page



101 MM X 101 MM ADHESIVE NOTEPADS

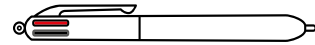

FABRIQUÉ À PARTIR DE 100% DE FIBRE RECYCLÉE* ET 100% RECYCLABLE



Profitez de sa grande zone d'impression !

Notes adhesives BIC® • BLOC-NOTES ADHÉSIFS

Marquage d'une couleur spécifique :

≥ 500 unités

Type de papier :

Recyclé 80g

Emballage spécial :
Emballage sous film plastique

N° de feuilles	Unités par pack
25	10
50	5

Techniques d'impression :





(DG)
NUMÉRIQUE

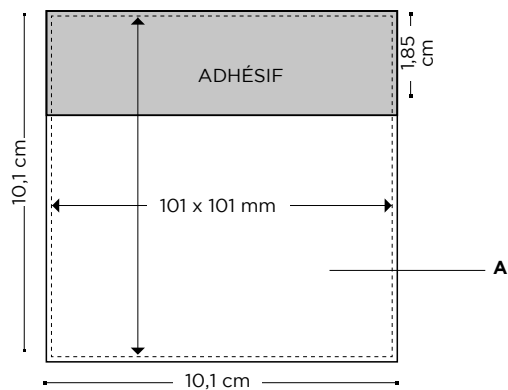

FABRIQUÉ EN ESPAGNE

Personnalisation :**BIC® 101 MM X 101 MM
ADHESIVE NOTEPADS****A DG:** Numérique
 25 @COlutions® 3516

 50 @COlutions® 3546

		Prix (€)				
		250-499	500-999	1000-2499	2500-4999	5000
 25	@COlutions® 3516					
	DG	-	1,00	0,70	0,52	0,43
 50	@COlutions® 3546					
	DG	-	1,26	1,07	0,85	0,70

Coûts supplémentaires :**Marquage d'une couleur spécifique sur les feuilles** 105€**Les prix incluent l'impression en quadrichromie.**

Les commandes doivent être un multiple de la quantité minimum indiquée.
Coût additionnel pour emballage sous film : 0,11€

Emballage externe :
 25
400 ± 9,5 Kg
 50
200 ± 9,1 Kg

*Pourcentage calculé sans la dernière page



101 MM X 130 MM ADHESIVE NOTEPADS

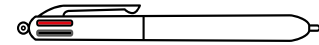

FABRIQUÉ À PARTIR DE 100% DE FIBRE RECYCLÉE* ET 100% RECYCLABLE

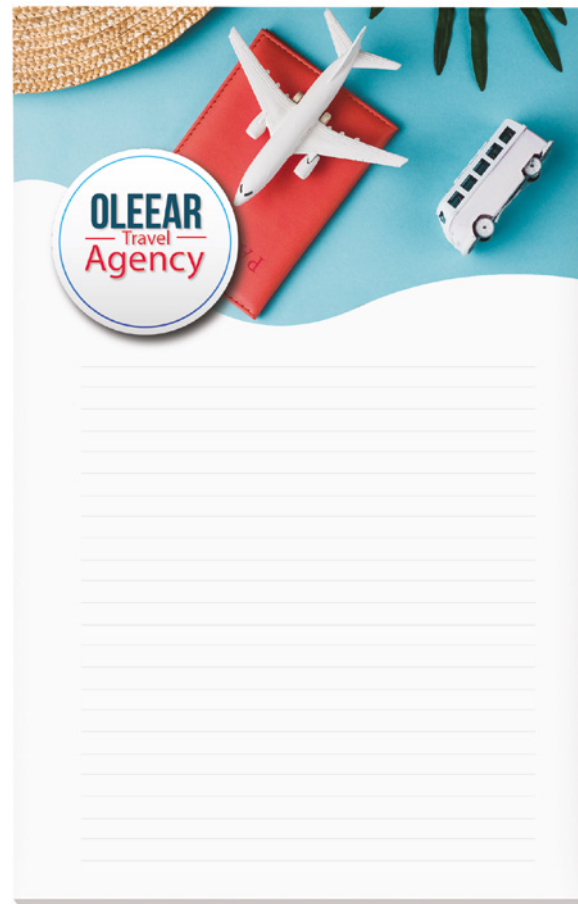
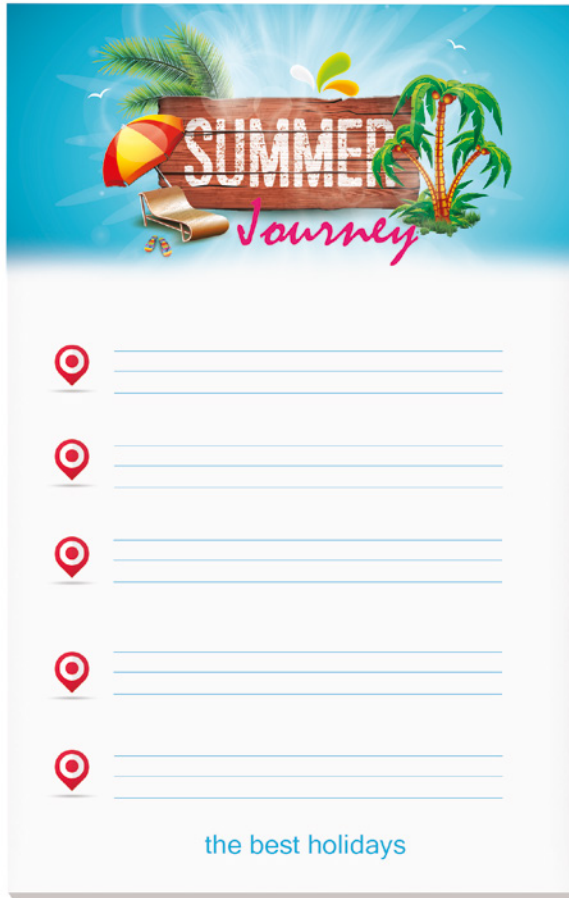

Notes adhesives BIC® • BLOC-NOTES ADHÉSIFS

130%

Grande surface d'impression pour de longs messages !
Pour que rien ne vous échappe !

Marquage d'une couleur spécifique :

≥ 500 unités

Type de papier :

Recyclé 80g

Emballage spécial :
Emballage sous film plastique

N° de feuilles	Unités par pack
25	10
50	5

Techniques d'impression :



(DG)
NUMÉRIQUE



FABRIQUÉ EN ESPAGNE

Personnalisation : **Commande minimale 500u.**





**BIC® 101 MM X 130 MM
ADHESIVE NOTEPADS**

A DG: Numérique

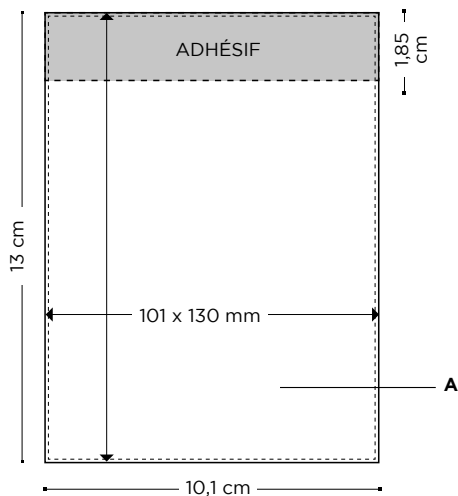
 25  3590

 50  3595



		BIC® 101 MM X 130 MM ADHESIVE NOTEPADS					Prix (€)
		250-499	500-999	1000-2499	2500-4999	5000	
	 3590						
	DG	-	1,20	1,02	0,76	0,65	
	 3595						
	DG	-	1,65	1,37	1,20	1,02	

Coûts supplémentaires :

Marquage d'une couleur spécifique sur les feuilles 105€

Les prix incluent l'impression en quadrichromie.

Les commandes doivent être un multiple de la quantité minimum indiquée.
Coût additionnel pour emballage sous film : 0,11€

Emballage externe :



250 ± 8,5 Kg



125 ± 8,2 Kg

*Pourcentage calculé sans la dernière page

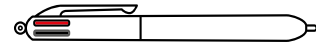

FABRIQUÉ À PARTIR DE 100% DE FIBRE RECYCLÉE* ET **100% RECYCLABLE**



Choisissez parmi les 7 formes en stock !
Formes spéciales sur demande

Notes adhesives BIC® • BLOC-NOTES ADHÉSIFS

Marquage d'une couleur spécifique :

≥ 500 unités

Type de papier :

Recyclé 80g

Emballage spécial :
Emballage sous film plastique

N° de feuilles	Unités par pack
25	10
50	5

Techniques d'impression :



(DG)
NUMÉRIQUE



FABRIQUÉ EN ESPAGNE

Personnalisation : Commande minimale 500u.



**BIC® SMALL ADHESIVE
DIE CUT NOTEPADS**

A DG: Numérique

 25 @ccolutions® 3619

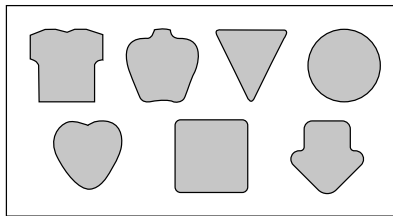
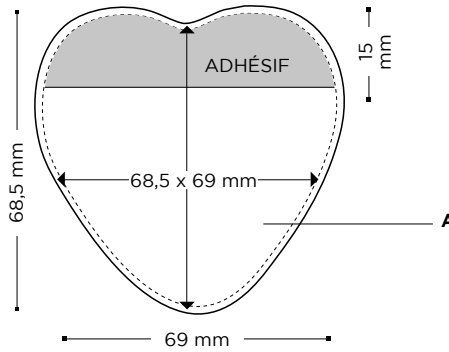
 50 @ccolutions® 3629



		Prix (€)				
		250-499	500-999	1000-2499	2500-4999	5000
 25	BIC® SMALL ADHESIVE DIE CUT NOTEPAD					
	@ccolutions® 3619					
	DG	-	0,97	0,77	0,53	0,43
 50	@ccolutions® 3629					
	DG	-	1,47	1,10	0,80	0,70

Coûts supplémentaires :

Marquage d'une couleur spécifique sur les feuilles	105€
Frais d'installation pour forme faite sur mesure (par commande et/ou forme)	1.195€
Renouvellement de commande	Gratuit

Les prix incluent l'impression en quadrichromie.
Les commandes doivent être un multiple de la quantité minimum indiquée.
Coût additionnel pour emballage sous film : 0,11€

Emballage externe :



 25

500 ± 6,2 Kg



 50

250 ± 6 Kg



MEDIUM ADHESIVE DIE CUT NOTEPADS

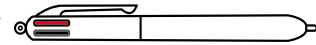

FABRIQUÉ À PARTIR DE 100% DE FIBRE RECYCLÉE* ET 100% RECYCLABLE



Notes adhesives BIC® • BLOC-NOTES ADHÉSIFS

125%



Choisissez parmi les 28 formes en stock !
Formes spéciales sur demande

Marquage d'une couleur spécifique :

≥ 500 unités

Type de papier :

Recyclé 80g

Emballage spécial :
Emballage sous film plastique

N° de feuilles	Unités par pack
25	10
50	5

Techniques d'impression :



(DG)
NUMÉRIQUE



FABRIQUÉ EN ESPAGNE

Personnalisation : **Commande minimale 500u.**





**BIC® MEDIUM ADHESIVE
DIE CUT NOTEPADS**

A DG: Numérique

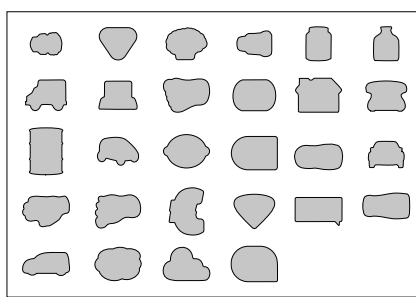
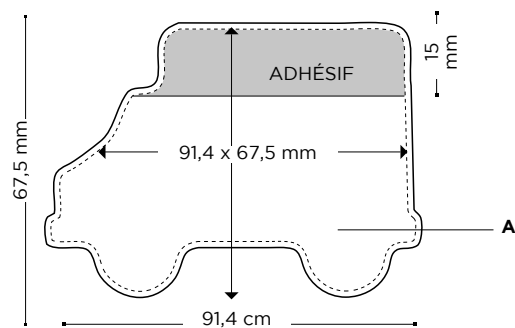
 25  **3602**

 50  **3606**



		Prix (€)				
		250-499	500-999	1000-2499	2500-4999	5000
	BIC® MEDIUM ADHESIVE DIE CUT NOTEPADS					
	 3602					
	DG	-	1,07	0,83	0,64	0,50
	 3606					
	DG	-	1,84	1,42	1,05	0,90

Coûts supplémentaires :

Marquage d'une couleur spécifique sur les feuilles

105€

Frais d'installation pour forme faite sur mesure (par commande et/ou forme)

1.195€

Renouvellement de commande

Gratuit

Les prix incluent l'impression en quadrichromie.

Les commandes doivent être un multiple de la quantité minimum indiquée.
Coût additionnel pour emballage sous film : 0,11€

Emballage externe :



 25

400 ± 6,6 Kg



 50

200 ± 6,4 Kg

*Pourcentage calculé sans la dernière page



BOOKLETS

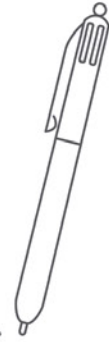

Un objet multifonctionnel idéal pour la prise de notes ! Double impact de votre message grâce à la couverture personnalisée et au bloc-notes Sticky Notes.

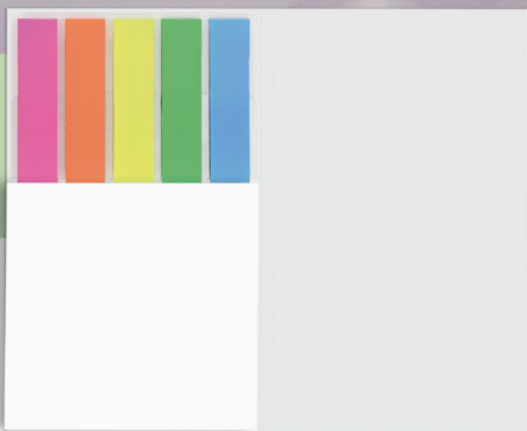



75 X 75 BOOKLET **ecolutions®**

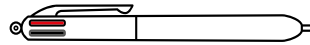

FABRIQUÉ À PARTIR DE 100% DE PAPIER
CERTIFIÉ FSC ET **100% RECYCLABLE**



Notes adhesives BIC® • BOOKLETS

100%

Type de papier :

Recyclé 80g

Emballage spécial :

Sachet plastique 1, 2 unités

Techniques d'impression :



(DG)
NUMÉRIQUE



FABRIQUÉ EN
ESPAGNE

Personnalisation :

BIC® 75 X 75 BOOKLET
A/B/C/D DG: Numérique



Commande minimale avec bloc non imprimé : 250u.

Commande minimale avec bloc imprimé : 500u.

 25 @CColutions® 3731

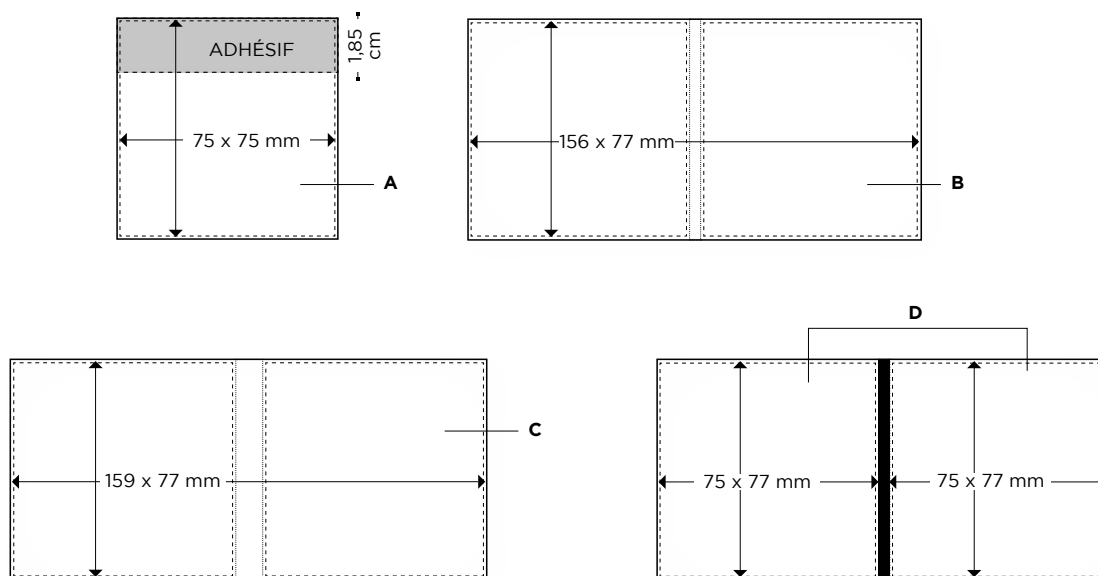
 50 @CColutions® 3737



		Prix (€)				
		250-499	500-999	1000-2499	2500-4999	5000
 25	BIC® 75 X 75 BOOKLET					
	@CColutions® 3731*					
	DG	1,71	1,42	1,28	1,05	0,96
 50	@CColutions® 3737					
	DG	2,16	1,79	1,57	1,35	1,24

Coûts supplémentaires :

	105€				
Marquage d'une couleur spécifique sur les feuilles					
Impression sur le bloc	-	0,07	0,07	0,07	0,06
Impression sur la couverture intérieure	0,08	0,07	0,07	0,07	0,06
Finition laminée mate au toucher doux	0,08	0,07	0,07	0,07	0,06

Les commandes doivent être un multiple de la quantité minimum indiquée.

BIC® Booklets: Les prix incluent l'impression en quadrichromie seulement sur la couverture extérieure.

Coût additionnel pour emballage sous film : 0,11€

*Commandes inférieures à 500 unités disponibles seulement avec BIC® Sticky Notes sans impression

Emballage externe :

 25

500 ± 7,8 Kg



 50

250 ± 7,3 Kg



75 X 75 ADHESIVE NOTEPAD WITH FLAG BOOKLET

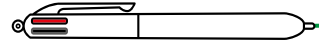

FABRIQUÉ À PARTIR DE 100% DE PAPIER
CERTIFIÉ FSC ET **100% RECYCLABLE**



*Le bloc multifonction
pour la prise de notes*

Notes adhesives BIC® • BOOKLETS

Type de papier :

Recyclé 80g

Emballage spécial :

Sachet plastique 1, 2, 3 unités

Techniques d'impression :



(DG)
NUMÉRIQUE



FABRIQUÉ EN
ESPAGNE

Personnalisation :

BIC® ADHESIVE NOTEPAD WITH FLAG BOOKLET

A/B/C DG: Numérique

 25 **©©olutions® 3732**

 25 Marque-pages par couleur

Commande minimale avec bloc non imprimé : 250u.

Commande minimale avec bloc imprimé : 500u.

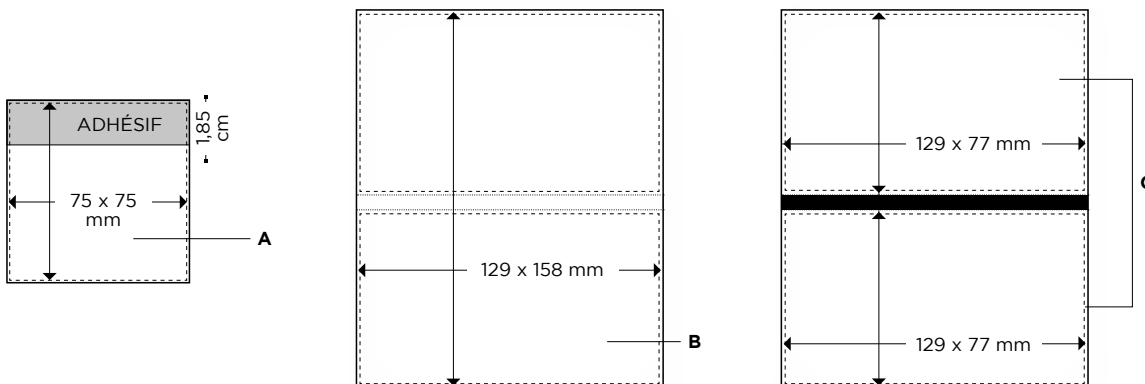

	Prix (€)				
BIC® ADHESIVE NOTEPADS WITH FLAG BOOKLET	250-499	500-999	1000-2499	2500-4999	5000
©©olutions® 3732*					
DG	3,66	3,05	2,50	1,88	1,65

Coûts supplémentaires :

Marquage d'une couleur spécifique sur les feuilles	105€				
Impression sur le bloc	-	0,07	0,07	0,07	0,06
Impression sur la couverture intérieure	0,08	0,07	0,07	0,07	0,06
Finition laminée mate au toucher doux	0,08	0,07	0,07	0,07	0,06

Les commandes doivent être un multiple de la quantité minimum indiquée.

BIC® Booklets: Les prix incluent l'impression en quadrichromie seulement sur la couverture extérieure.

Coût additionnel pour emballage sous film : 0,11€

*Commandes inférieures à 500 unités disponibles seulement avec BIC® Sticky Notes sans impression

Emballage externe :



200 ± 5,2 Kg

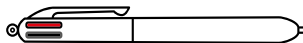

FABRIQUÉ À PARTIR DE 100% DE PAPIER
CERTIFIÉ FSC ET **100% RECYCLABLE**



Double impact de votre message grâce
à la couverture personnalisée et au bloc-notes
sticky notes dans sa taille la plus populaire

Type de papier : Recyclé 80g**Emballage spécial :**



Sachet plastique 1, 2, 3 unités

Techniques d'impression :(DG)
NUMÉRIQUEFABRIQUÉ EN
ESPAGNE





Personnalisation :

BIC® 101 X 75 BOOKLET

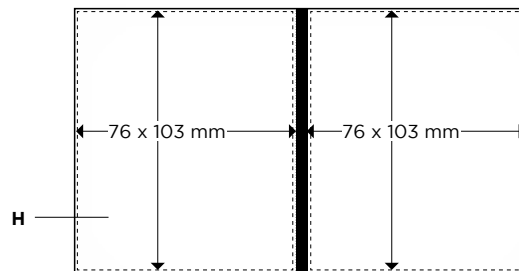
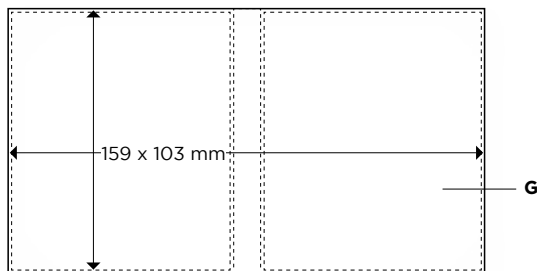
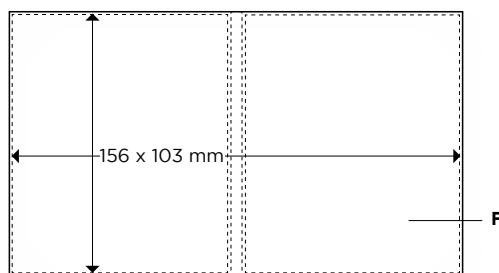
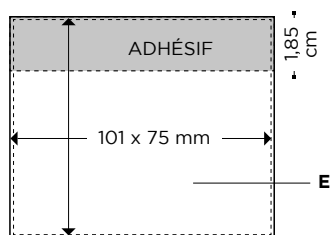
E/F/G/H DG: Numérique

-  25  3738 **Commande minimale avec bloc non imprimé : 250u / Commande minimale avec bloc imprimé : 500u.**
 50  3739 **Commande minimale avec bloc imprimé : 250u.**



		Prix (€)				
		250-499	500-999	1000-2499	2500-4999	5000
 25	BIC® 101 X 75 BOOKLET					
	 3738*					
	DG	1,96	1,63	1,43	1,22	1,12
 50	 3739					
	DG	2,59	2,18	1,91	1,59	1,47

Coûts supplémentaires :

	105€				
Marquage d'une couleur spécifique sur les feuilles					
Impression sur le bloc	0,08	0,07	0,07	0,07	0,06
Impression sur la couverture intérieure	0,08	0,07	0,07	0,07	0,06
Finition laminée mate au toucher doux	0,08	0,07	0,07	0,07	0,06

Les commandes doivent être un multiple de la quantité minimum indiquée.

BIC® Booklets: Les prix incluent l'impression en quadrichromie seulement sur la couverture extérieure.

Coût additionnel pour emballage sous film : 0,11€

*Commandes inférieures à 500 unités disponibles seulement avec BIC® Sticky Notes sans impression

Emballage externe :



500 ± 5,9 Kg



250 ± 5,1 Kg



150 X 150 MM BOOKLET ORGANISER

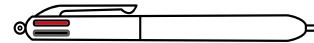

FABRIQUÉ À PARTIR DE 100% DE PAPIER CERTIFIÉ FSC ET **100% RECYCLABLE**



Notes adhesives BIC® • BOOKLETS

60%

Type de papier :

Recyclé 80g

Emballage spécial :

Sachet plastique 1, 2, 3 unités

Techniques d'impression :



(DG)
NUMÉRIQUE



FABRIQUÉ EN
ESPAGNE

Personnalisation :

**BIC® 150 X 150
BOOKLET ORGANISER**

Commande minimale 500u.

A/B/C DG: Numérique

 100  3745

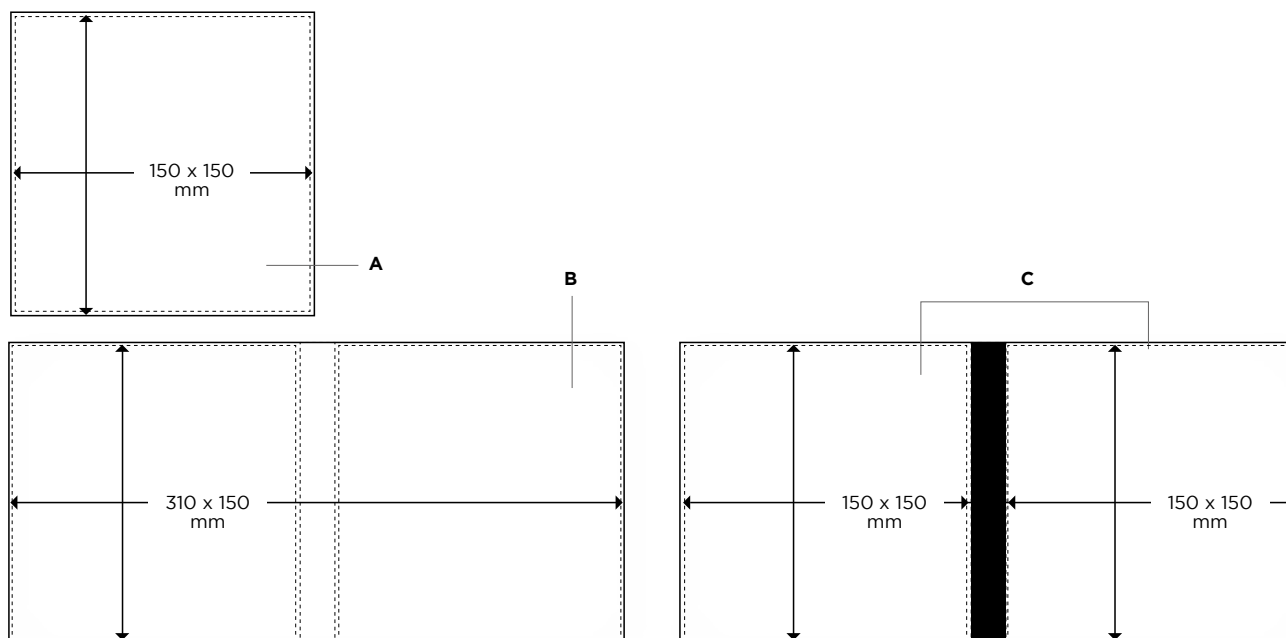

	Prix (€)				
BIC® 150 X 150 BOOKLET ORGANISER	250-499	500-999	1000-2499	2500-4999	5000
eSolutions® 3745					
DG	-	5,10	4,74	4,25	3,96

Coûts supplémentaires :

Marquage d'une couleur spécifique sur les feuilles	105€				
Impression sur le bloc	-	0,07	0,07	0,07	0,06
Impression sur la couverture intérieure	0,08	0,07	0,07	0,07	0,06
Finition laminée mate au toucher doux	0,08	0,07	0,07	0,07	0,06

Les commandes doivent être un multiple de la quantité minimum indiquée.

BIC® Booklets: Les prix incluent l'impression en quadrichromie seulement sur la couverture extérieure.
Coût additionnel pour emballage sous film : 0,11€

Emballage externe :



40 ± 6,4 Kg



150 X 150 MM BOOKLET WITH PEN LOOP

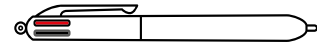

FABRIQUÉ À PARTIR DE 100% DE PAPIER
CERTIFIÉ FSC ET **100% RECYCLABLE**

3746



Suggestion de présentation
avec le BIC® Wide Body™ Digital.
Combinez cet article avec n'importe
quel instrument d'écriture

Avec une boucle pour insérer le stylo

Notes adhesives BIC® • BOOKLETS

	Prix (€)				
BIC® 150 X 150 BOOKLET WITH PEN LOOP	250-499	500-999	1000-2499	2500-4999	5000
eco!utions® 3746					
DG	-	6,07	5,66	5,04	4,72
Stylos 1080					
DG	-	1,38	1,28	1,19	1,12

Coûts supplémentaires :

Marquage d'une couleur spécifique sur les feuilles	105€				
Impression sur le bloc	-	0,07	0,07	0,07	0,06
Impression sur la couverture intérieure	0,08	0,07	0,07	0,07	0,06
Finition laminée mate au toucher doux	0,08	0,07	0,07	0,07	0,06

Les commandes doivent être un multiple de la quantité minimum indiquée.
BIC® Booklets: Les prix incluent l'impression en quadrichromie seulement sur la couverture extérieure.
Coût additionnel pour emballage sous film : 0,11€
Stylo non inclus.

Type de papier :

Recyclé 80g

Emballage spécial :

Sachet plastique 1, 2, 3 unités



(DG)
NUMÉRIQUE

Techniques d'impression :



40 ± 6,7 Kg

Emballage externe :



FABRIQUÉ EN
ESPAGNE

Personnalisation :

BIC® 150 X 150 BOOKLET WITH PEN LOOP

A/B/C DG: Numérique

I SP: max. 1 col.

G DG: Numérique (zone image)

H DG: Numérique (zone texte)

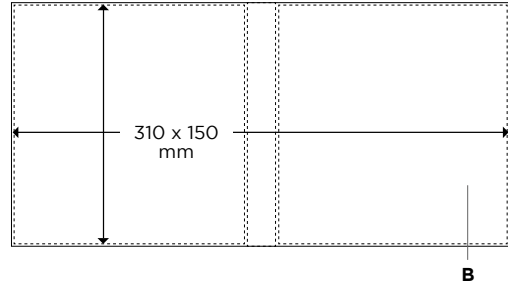
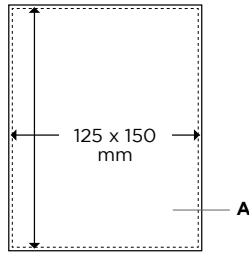

100 solutions® 3746

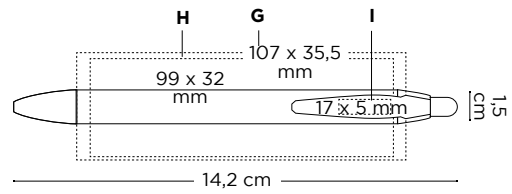
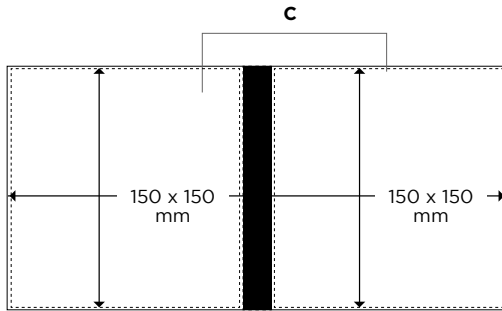

Combinaison de couleurs standards

Commande minimale 500u.

Corps

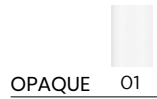

Bouton

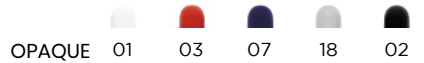

Clip

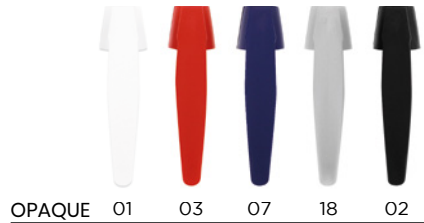

Section

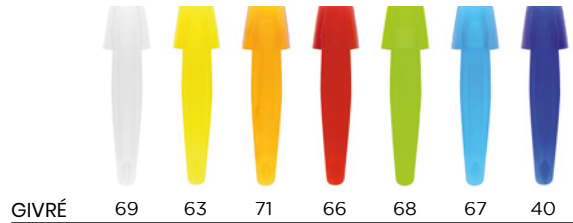
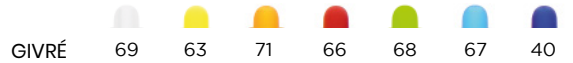



CLIC STIC MINI ORGANISER **eco**olutions®
 & **BIC® CLIC STIC MINI DIGITAL ORGANISER** **eco**olutions®

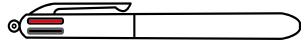

FABRIQUÉ À PARTIR DE 100% DE PAPIER
 CERTIFIÉ FSC ET **100% RECYCLABLE**



BIC® CLIC STIC MINI ORGANISER
 3735



Utilisez ce set de rangement
 tout-en-un pour vos réunions et
 vos notes quotidiennes

70%



Cet article exceptionnel pour une communication très impactante comprend un stylo BIC® clic stic Mini Digital

BIC® CLIC STIC MINI DIGITAL ORGANISER
3735



Impressio numérique sur tous les côtés !

Notes adhesives BIC® • BOOKLETS



CLIC STIC MINI ORGANISER & BIC® CLIC STIC MINI DIGITAL ORGANISER

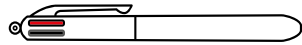

Combinaison de couleurs standards



Bouton

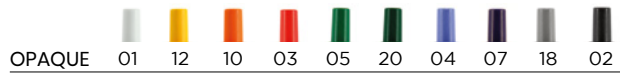
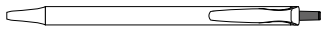

Clip

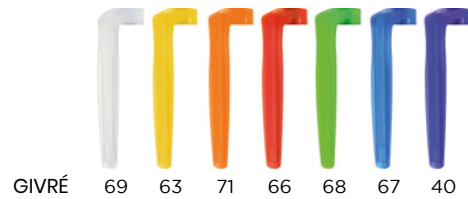
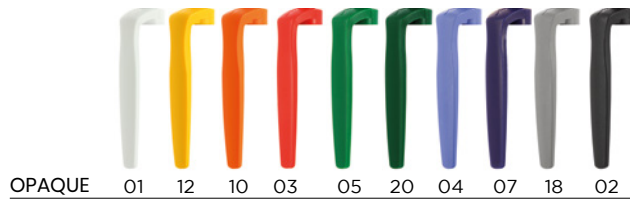
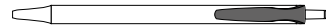

Section

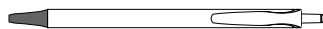

Cops



Notes adhesives BIC® • BOOKLETS

Type de papier :

Recyclé 80g

Emballage spécial :

Sachet plastique 1, 2 unités



Techniques d'impression :



(DG)
NUMÉRIQUE

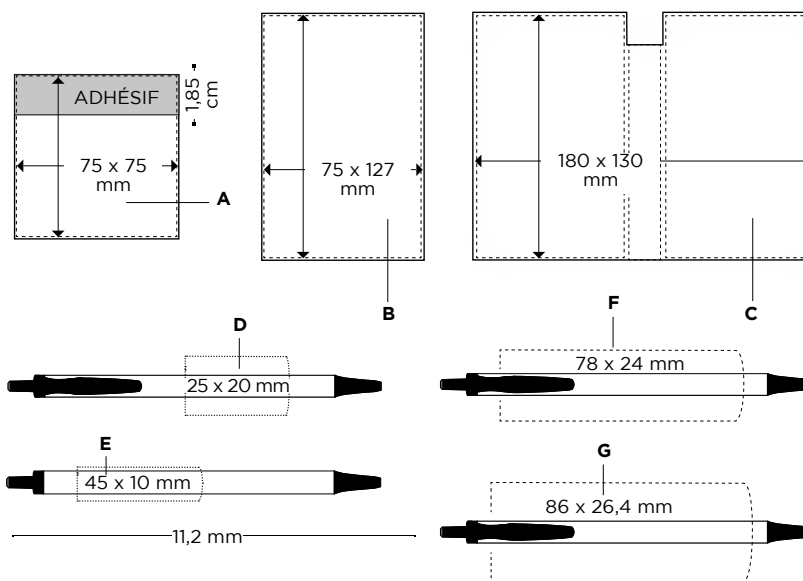

FABRIQUÉ EN
ESPAGNE

Personnalisation :**BIC® CLIC STIC MINI ORGANISER & DIGITAL**
3735**A/B/C DG:** Numérique.**D/E SP:** max 1 col.**F DG:** Numérique (zone texte)
(disponible en corps blanc)**G DG:** Numérique (zone image)
(disponible en corps blanc) 20 Bloc-notes adhésifs 40 Scratch pad 25 Marque-pages par couleur**Commande minimale avec bloc non imprimé : 250u.****Commande minimale avec bloc imprimé : 500u.****BIC® CLIC STIC MINI ORGANISER /**
MINI DIGITAL ORGANISER
3735

	250-499	500-999	1000-2499	2500-4999	5000
DG/SP	5,21	4,33	3,93	3,48	3,23
DG/DG	5,60	4,65	4,21	3,72	3,49

Prix (€)

Coûts supplémentaires :

Marquage d'une couleur spécifique sur les feuilles			105€		
Impression sur le bloc	-	0,07	0,07	0,07	0,06
Impression sur la couverture intérieure	0,08	0,07	0,07	0,07	0,06
Finition laminée mate au toucher doux	0,08	0,07	0,07	0,07	0,06

Les commandes doivent être un multiple de la quantité minimum indiquée.BIC® Booklets: Les prix incluent l'impression en quadrichromie seulement sur la couverture extérieure.
Coût additionnel pour emballage sous film : 0,11€**Emballage externe :****125 ± 7 Kg**

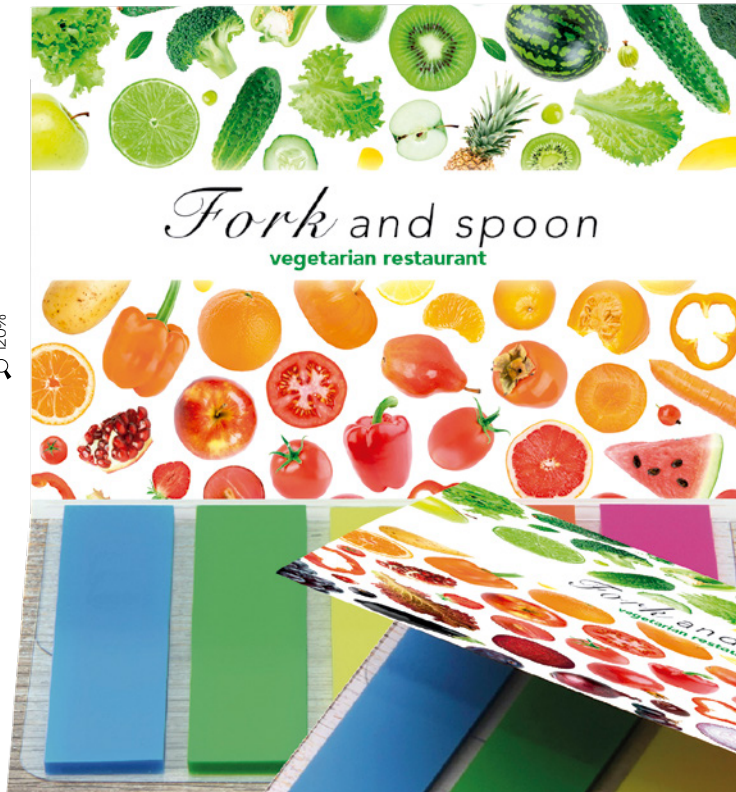
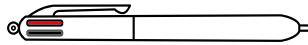

120%

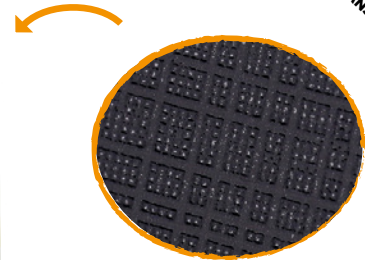

Choisissez la finition de la couverture de votre livret : finition brillante, laminée à motifs ou laminée mat au toucher doux

25 marque-pages adhésifs de chaque couleur !

Emballage spécial :

Sachet plastique 1, 2, 3 unités

Techniques d'impression :



(DG)
NUMÉRIQUE



FABRIQUÉ EN ESPAGNE

Personnalisation :

BIC® FLAG BOOKLET

Commande minimale 250u.

A/B DG: Numérique

 25 3730

 25 Marque-pages par couleur

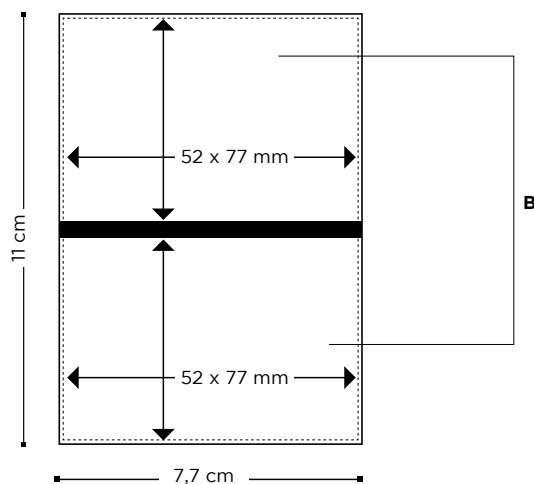
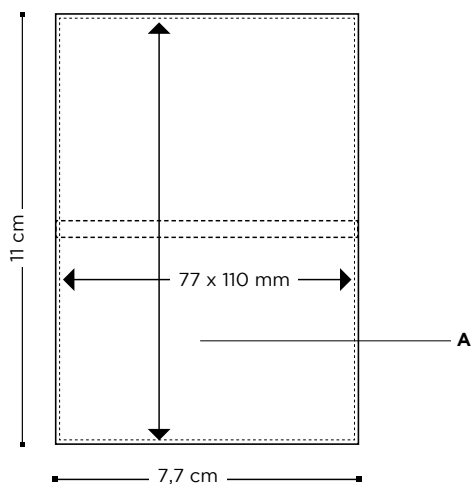

	Prix (€)				
BIC® FLAG BOOKLET	250-499	500-999	1000-2499	2500-4999	5000
3730					
DG	2,17	1,81	1,40	0,97	0,83

Coûts supplémentaires :

Impression sur la couverture intérieure	0,08	0,07	0,07	0,07	0,06
Matt soft-feel/pattern laminated finish	0,08	0,07	0,07	0,07	0,06

Les commandes doivent être un multiple de la quantité minimum indiquée.
 BIC Booklets: Les prix incluent l'impression en quadrichromie seulement sur la couverture extérieure.
 Coût additionnel pour emballage sous film : 0,11€

Emballage externe :



 25

150 ± 1,56 Kg

Emballage optionnel:
 Sachet plastique 1, 2, 3 unités



75 X 127 MM NON-ADHESIVE SCRATCH PAD

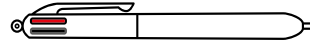

Blocs papier Non Adhesifs, indispensable pour vos listes et vos notes

FABRIQUÉ À PARTIR DE 100% DE PAPIER
CERTIFIÉ FSC ET **100% RECYCLABLE**

3760 / 3761





Commande minimale 500u.

Personnalisation :

**BIC® 75 X 127 NON-ADHESIVE
SCRATCH PAD**

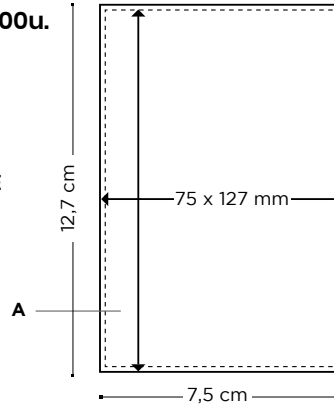
A DG: Numérique



		Prix (€)				
		250-499	500-999	1000-2499	2500-4999	5000
	BIC® 75 X 127 NON-ADHESIVE SCRATCH PAD					
	eColutions® 3760					
	DG	-	0,51	0,42	0,25	0,19
	eColutions® 3761					
	DG	-	0,76	0,59	0,38	0,34

Coûts supplémentaires :

Marquage d'une couleur spécifique sur les feuilles 105€

Les prix incluent l'impression en quadrichromie.
Les commandes doivent être un multiple de la quantité minimum indiquée.
Coût additionnel pour emballage sous film : 0,11€

Type de papier : **Techniques
d'impression :**

Recyclé 60g



(DG)
NUMÉRIQUE

Emballage externe :



 20

400 ± 5,4 Kg



 40

200 ± 5,2 Kg

Emballage optionnel:
Sachet plastique 1, 2, 3 unités



FABRIQUÉ EN
ESPAGNE



96 X 152 MM NON-ADHESIVE SCRATCH PAD

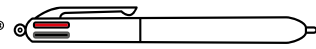

FABRIQUÉ À PARTIR DE 100% DE PAPIER
CERTIFIÉ FSC ET **100% RECYCLABLE**

3762 / 3763



Commande minimale 500u.

Personnalisation :

**BIC® 96 X 152 NON-ADHESIVE
SCRATCH PAD**

A DG: Numérique

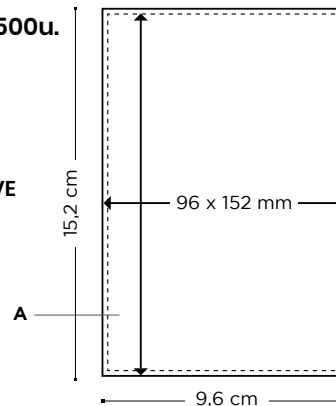

		Prix (€)				
		250-499	500-999	1000-2499	2500-4999	5000
20	BIC® 96 X 152 NON-ADHESIVE SCRATCH PAD					
	eColutions® 3762					
	DG	-	0,63	0,52	0,30	0,24
40	eColutions® 3763					
	DG	-	0,96	0,76	0,48	0,43

Coûts supplémentaires :

Marquage d'une couleur spécifique sur les feuilles

105€

Les prix incluent l'impression en quadrichromie.

Les commandes doivent être un multiple de la quantité minimum indiquée.
Coût additionnel pour emballage sous film : 0,11€

Type de papier : **Techniques
d'impression :**

Recyclé 60g



(DG)
NUMÉRIQUE

Emballage externe :



20

350 ± 8,6 Kg



40

200 ± 8 Kg

Emballage optionnel:

Sachet plastique 1, 2, 3 unités



FABRIQUÉ EN
ESPAGNE

BRIQUETS BIC®

BRIQUETS

BIC® J25 Lighter	204
BIC® J23 Lighter	208
BIC® J26 Lighter	212
BIC® J38 Lighter	216
BIC® J39 Lighter	220
BIC® Mega Lighter	224

COQUES DE BRIQUETS

BIC® Styl'it Luxury Case	226
BIC® Aluminium Flat Case	228
BIC® Clip Case	229
BIC® 3D Case	230

AUTRES PRODUITS

BIC® Pocket Ashtray	232
---------------------	-----

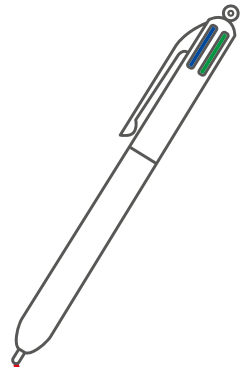

BRIQUETS



Briquets de poche UN CHOIX SIMPLE

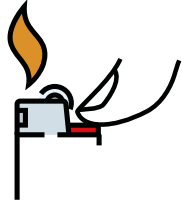

Tous les briquets de poche BIC® respectent ou dépassent les exigences des normes et réglementations internationales (ISO 9994, EN 13869, ASTM F400, US CPSC)

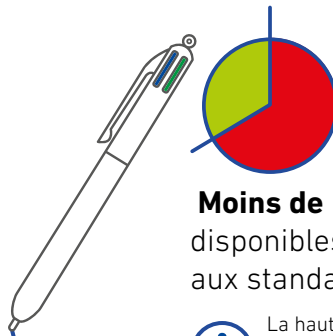

Moins de 1/3 des modèles de briquets disponibles sur le marché européen répondent aux standards de sécurité européens¹.



La hauteur de la flamme, la résistance aux chutes, la stabilité de la flamme et l'extinction de la flamme sont quelques unes des caractéristiques testées par la norme ISO 9994

Conform ISO 9994

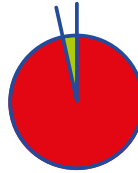

Seulement 3% des briquets électroniques disponibles en Europe sont conformes à la norme standard EN 13869².



La norme EN 13869 exige que tous les briquets de poche vendus dans l'UE fonctionnent avec la sécurité enfants tout au long de la durée de vie du briquet

Conform EN 13869 85%

¹Source : Tests réalisés par des laboratoires indépendants accrédités de 2015 à 2018.

²Source : Tests SGS sur 105 modèles piézo à mouvement vertical entre avril 2017 et juin 2018.

Un briquet "sécurité enfants" n'est pas un briquet exempt de tout risque pour les enfants: c'est un briquet que 85% au moins des enfants de moins de 51 mois ne peuvent pas faire fonctionner, ce qui implique que la proportion des enfants en cause capables de l'actionner peut aller jusqu'à 15%. Les adultes doivent donc toujours veiller à ce que les briquets soient hors de portée des enfants, même s'il s'agit de briquets « sécurité enfants ».

LE
N°1
MONDIAL

Briquets BIC®
Notre qualité. Votre sécurité

EN BRIQUETS
DE MARQUE

BIC J25
Digital lighter



page 206

Jusqu'à 1450

BIC J23
Digital lighter



page 208

Jusqu'à 1800

BIC J26
Digital lighter



page 212

Jusqu'à 3000

BIC J38
Digital lighter



page 216

Jusqu'à 1800

BIC J39
Digital lighter



page 220

Jusqu'à 1050

BIC Mega
Lighter



page 224

Jusqu'à 750

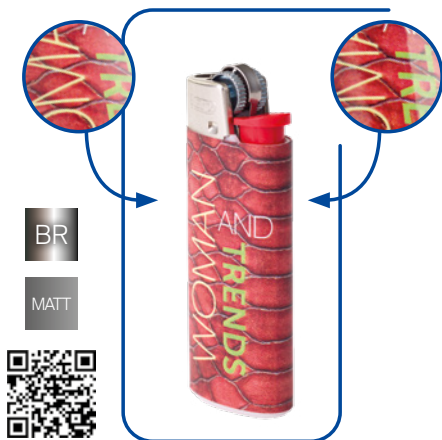

DIGITAL BRILLIANT
DIGITAL MATT
Brillante ou mate ?
Choisissez la finition
qui vous plaît !



METALLIC
Créez de superbes effets !
Effets métalliques sur les
textes, les images et le fond.



HOLOGRAPHIC GOLD
HOLOGRAPHIC SILVER
Démarez-vous de la
concurrence ! Jouez avec
de jolis reflets légers de
couleurs en utilisant la
finition holographique.



PUFFY PRINTING
Faites preuve d'originalité !
Faites ressortir votre
marque grâce à notre
encre « puffy » et donnez
ainsi du relief à votre logo.



UV PRINTING
Faites ressortir votre marque avec une
finition très brillante ! Combinez les
finitions mates et brillantes
pour souligner les contrastes
et faire ressortir le motif sur fond mat.



SANDY
Créez un effet « papier
de verre » grâce à une
surface granuleuse.



PUFFY GLITTER
Admirez et touchez
la texture colorée à
paillettes !



GLOW IN THE DARK
Faites briller votre
marque, même dans
le noir !



BIC LIGHTERS

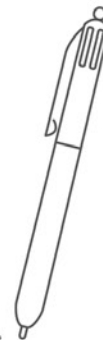

Le célèbre briquet BIC®, une icône indémodable, avec un design toujours tendance ! 3 tailles différentes et une vaste gamme de combinaisons de couleurs.



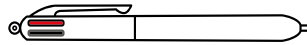

2360



Disponible en *britePix*

57

Briquets BIC • BRIQUETS



Disponible en *britePix*

Pastel - 2360

5C

2360

Gold Hood
2430

All Black
2364



Disponible en *britePix*

83

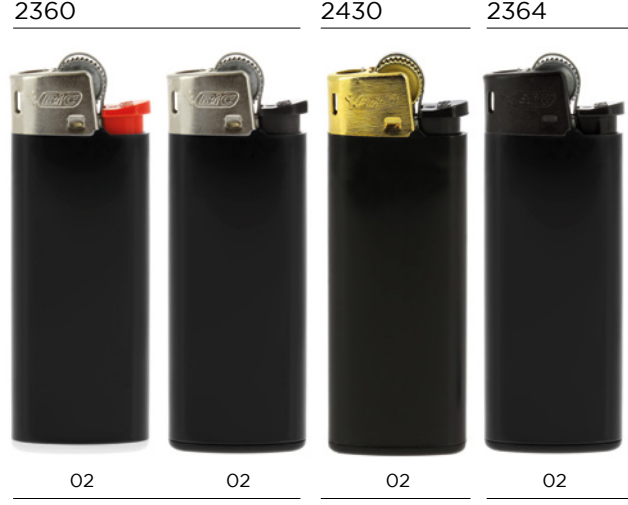

Disponible en *britePix*

Disponible en *britePix* Disponible en *britePix*

Commande minimale 300u.

Personnalisation :

BIC® J25 LIGHTER

2360/2364/2430

A/C SP: max. 4 col.

BIC® J25 LIGHTER *britePix™*

2360/2364/2430

A/C BP: Numérique

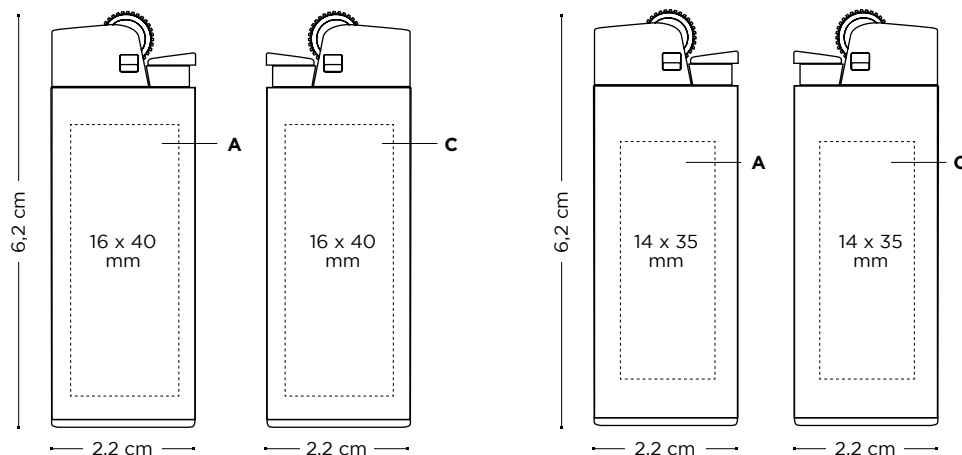

BIC® J25 LIGHTER	Prix (€)				
	300-599	600-1199	1200-2999	3000-5099	5100
2360					
SP	1,25	1,15	1,09	1,06	1,04
BP	1,48	1,38	1,31	1,27	1,23
2364					
SP	1,42	1,38	1,30	1,21	1,14
BP	1,67	1,61	1,50	1,41	1,34
2430					
SP	1,66	1,53	1,45	1,41	1,38
BP	1,90	1,76	1,67	1,62	1,57
Frais d'impression supplémentaires par couleur et position					
SP	0,13	0,13	0,13	0,13	0,09
BP	0,23	0,21	0,20	0,19	0,18

Les prix incluent 1 couleur de marquage en sérigraphie sur une position.
Les prix incluent le marquage BritePix™ sur le corps

Jusqu'à 1450 allumages

Conform EN 13869 85% Recyclé Conform ISO 9994

Emballage :



Emballage standard : barquette de 50 u.

Techniques d'impression :



(SP) SÉRIGRAPHIE



(BP) britePix™



Emballage externe :



600 ± 7,6 Kg



Pastel FABRIQUÉ EN FRANCE



FABRIQUÉ EN ESPAGNE



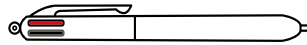

BR PUFFY

BIC® J25 DIGITAL LIGHTER
2360



MATT M



MATT PUFFY



MATT PUFFY



BR



MATT UV

Commande minimale 600u.

Personnalisation :

BIC® J25 DIGITAL LIGHTER

2360

A DG: Numérique

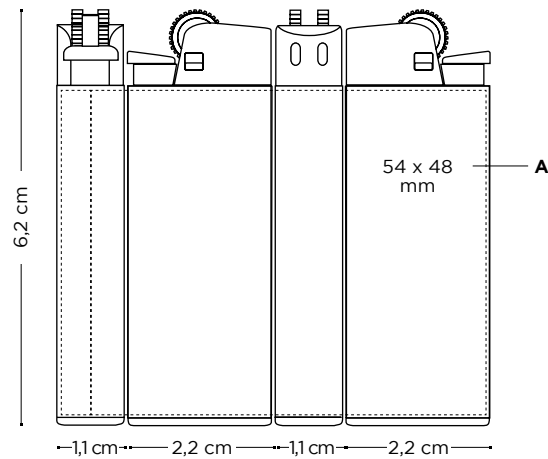

	Prix (€)				
BIC® J25 DIGITAL LIGHTER	300-599	600-1199	1200-2999	3000-5099	5100
2360					
DG	-	1,72	1,62	1,52	1,43

	Finitions numériques - coût supplémentaire					Commande minimale
BR MATT	Gratuit					600 u.
H	-	0,26	0,26	0,26	0,18	600 u.
PUFFY	-	-	-	-	0,18	5.100 u.
M	①					50.000 u.
UV	-	-	-	-	0,18	5.100 u.
SA	-	-	-	-	0,18	5.100 u.
PUFFY GLITTER	-	-	-	-	0,18	5.100 u.
GLOW	-	-	-	-	0,18	5.100 u.

Les prix incluent l'impression numérique sur le corps.

① Prix sur demande.

Jusqu'à 1450 allumages

Conform EN 13869 85% Conform ISO 9994

Emballage :



Emballage standard :
barquette de 50 u.

Techniques d'impression :



(DG)
NUMÉRIQUE

Emballage externe :



600 ± 7,6 Kg



FABRIQUÉ
EN ESPAGNE

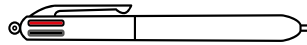

Fin et élégant, il se glisse partout !



2340



57

12

10

03

5C



59

05

24

04

25

02

*48h non disponible en impression numérique

Commande minimale 300u.

Personnalisation :

BIC® J23 LIGHTER

2340

A/C SP: max. 4 col.

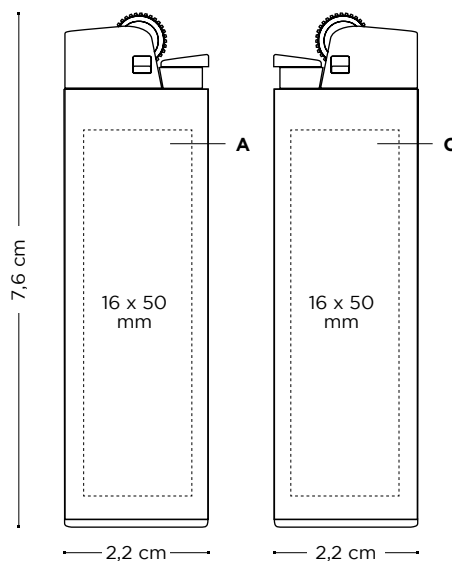

	Prix (€)				
BIC® J23 LIGHTER	300-599	600-1199	1200-2999	3000-5099	5100
2340					
SP	1,37	1,31	1,23	1,15	1,12

Frais d'impression supplémentaires par couleur et position

SP	0,13	0,13	0,13	0,13	0,09
-----------	------	------	------	------	------

Les prix incluent 1 couleur de marquage en sérigraphie sur une position.

Jusqu'à 1800
allumages

Conform
EN 13869

85%
RECYCLÉ

Conform
ISO 9994

Emballage :



Emballage standard :
barquette de 50 u.

Techniques d'impression :



(SP)
SÉRIGRAPHIE

Emballage externe :



600 ± 9,5 Kg



FABRIQUÉ
EN FRANCE

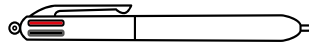

MATT M

BIC® J23 DIGITAL LIGHTER
2340



BR PUFFY



MATT PUFFY UV

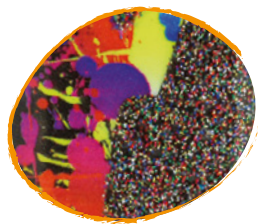

BR PUFFY SUMMER



BR

Commande minimale 600u.

Personnalisation :

BIC® J23 DIGITAL LIGHTER

2340

A DG: Numérique

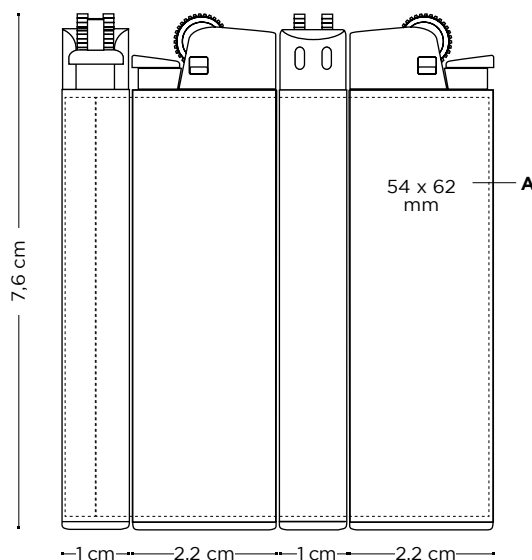

					Prix (€)
BIC® J23 DIGITAL LIGHTER	300-599	600-1199	1200-2999	3000-5099	5100
2340					
DG	-	1,87	1,77	1,68	1,60

Finitions numériques - coût supplémentaire						Commande minimale		
BR	MATT	Brilliant ou matt	Gratuit			600 u.		
H		Holographic	-	0,26	0,26	0,26	0,18	600 u.
PUFFY		Impression Puffy	-	-	-	-	0,18	5.100 u.
M		Metallic	①					50.000 u.
UV		UV	-	-	-	-	0,18	5.100 u.
SA		Sandy	-	-	-	-	0,18	5.100 u.
PUFFY GLITTER		Puffy Glitter	-	-	-	-	0,18	5.100 u.
GLOW		Glow in the dark	-	-	-	-	0,18	5.100 u.

Les prix incluent l'impression numérique sur le corps.

① Prix sur demande.

Jusqu'à 1800 allumages

Conform EN 13869 85% Recyclé Conform ISO 9994

Emballage :



Emballage standard : barquette de 50 u.

Techniques d'impression :



(DG) NUMÉRIQUE

Emballage externe :



600 ± 9,5 Kg



FABRIQUÉ EN FRANCE

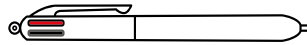

Longue durée : jusqu'à 3 000 allumages



2320



*48h non disponible en impression numérique

Commande minimale 300u.

Personnalisation :

BIC® J26 LIGHTER

2320

A/C SP: max. 4 col.

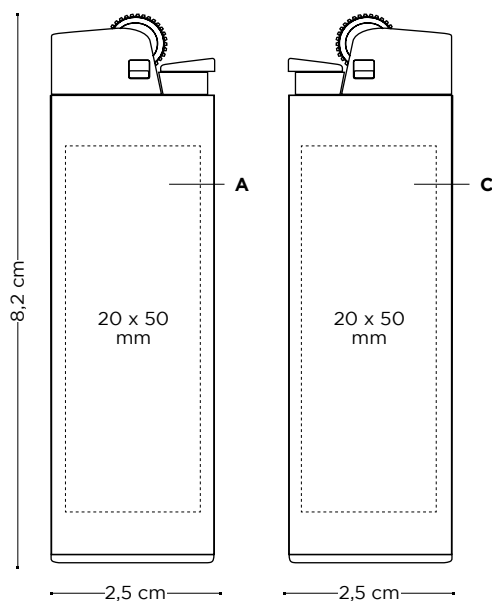

	Prix (€)				
BIC® J26 LIGHTER	300-599	600-1199	1200-2999	3000-5099	5100
2320					
SP	1,62	1,49	1,41	1,35	1,28

Frais d'impression supplémentaires par couleur et position

SP	0,13	0,13	0,13	0,13	0,09
-----------	------	------	------	------	------

Les prix incluent 1 couleur de marquage en sérigraphie sur une position.

Jusqu'à 3000
allumages

Conform
EN 13869

85%
RECYCLÉ

Conform
ISO 9994

Emballage :



Emballage standard :
barquette de 50 u.

Techniques d'impression : **Emballage externe :**



(SP)
SÉRIGRAPHIE



600 ± 15,1 Kg



FABRIQUÉ
EN ESPAGNE

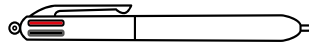

MATT M PUFFY

BIC® J26 DIGITAL LIGHTER
2320



BR H

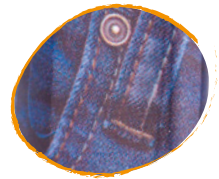

BR M



MATT



MATT UV



MATT M

Commande minimale 600u.

Personnalisation :

BIC® J26 DIGITAL LIGHTER

2320

A DG: Numérique

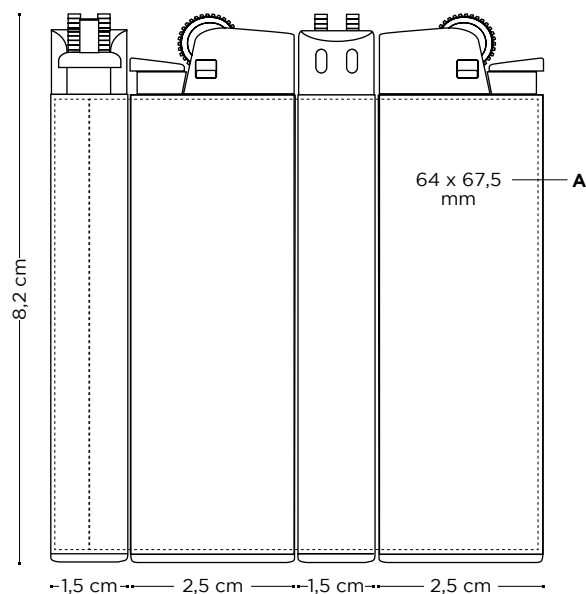

	Prix (€)				
BIC® J26 DIGITAL LIGHTER	300-599	600-1199	1200-2999	3000-5099	5100
2320					
DG	-	2,18	2,07	1,96	1,82

Finitions numériques - coût supplémentaire						Commande minimale	
	Brilliant ou matt	Gratuit				600 u.	
	Holographic	-	0,26	0,26	0,26	0,18	600 u.
	Impression Puffy	-	-	-	-	0,18	5.100 u.
	Metallic	①				50.000 u.	
	UV	-	-	-	-	0,18	5.100 u.
	Sandy	-	-	-	-	0,18	5.100 u.
	Puffy Glitter	-	-	-	-	0,18	5.100 u.
	Glow in the dark	-	-	-	-	0,18	5.100 u.

Les prix incluent l'impression numérique sur le corps.

① Prix sur demande.

Jusqu'à 3000 allumages

Conform EN 13869 **85%** **Conform ISO 9994**

Emballage :



Emballage standard :
barquette de 50 u.

Techniques d'impression :



(DG)
NUMÉRIQUE

Emballage externe :



600 ± 15,1 Kg



FABRIQUÉ
EN ESPAGNE

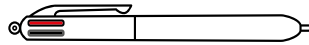

Allumage confortable !

Standard - 2452

Gold Hood - 2451



57



57



57



03

100%



25



02



02



Commande minimale 300u.

Personnalisation :

BIC® J38 LIGHTER

2452/2451

A/B SP: max. 4 col.

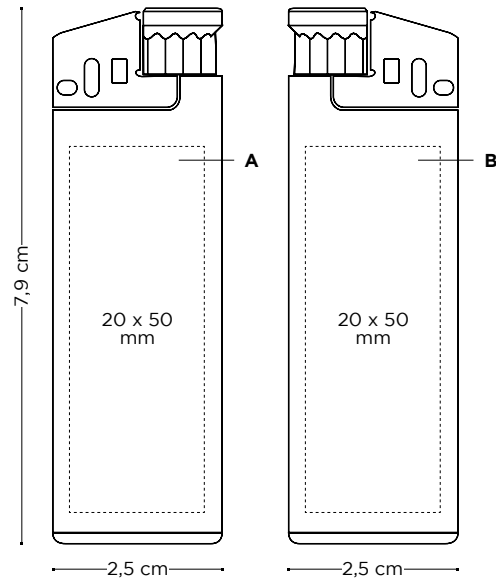

	Prix (€)				
BIC® J38 LIGHTER	300-599	600-1199	1200-2999	3000-5099	5100
2452					
SP	1,88	1,79	1,71	1,63	1,55
2451					
SP	2,27	2,17	2,07	1,97	1,88
Frais d'impression supplémentaires par couleur et position					
SP	0,13	0,13	0,13	0,09	0,09

Les prix incluent 1 couleur de marquage en sérigraphie sur une position.

Jusqu'à 1800 allumages

Conform EN 13869 85% Recyclé Conform ISO 9994

Emballage :



Emballage standard : barquette de 50 u.

Techniques d'impression : Emballage externe :



(SP) SÉRIGRAPHIE



600 ± 13,2 Kg



FABRIQUÉ EN ESPAGNE

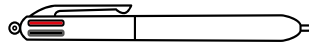

BR SA

BIC® J38 LIGHTER DIGITAL
Standard - 2452



57



57 BR

100%

360°



57



BR PUFFY GLITTER



BR GLOW



MATT M

Commande minimale 600u.

Personnalisation :

BIC® J38 DIGITAL LIGHTER

2452

A DG: Numérique

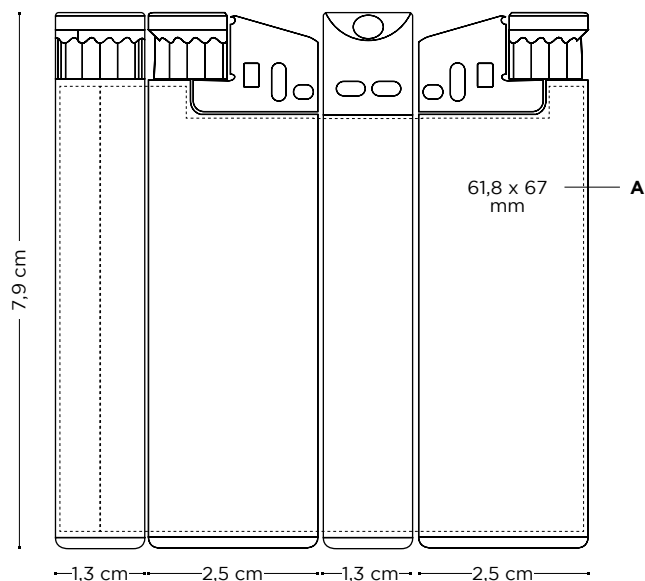

	Prix (€)				
BIC® J38 DIGITAL LIGHTER	300-599	600-1199	1200-2999	3000-5099	5100
2452					
DG	-	2,06	1,96	1,87	1,77

Finitions numériques - coût supplémentaire						Commande minimale		
BR	MATT	Brilliant ou matt	Gratuit			600 u.		
H		Holographic	-	0,26	0,26	0,26	0,18	600 u.
PUFFY		Impression Puffy	-	-	-	-	0,18	5.100 u.
M		Metallic	①					50.000 u.
UV		UV	-	-	-	-	0,18	5.100 u.
SA		Sandy	-	-	-	-	0,18	5.100 u.
PUFFY GLITTER		Puffy Glitter	-	-	-	-	0,18	5.100 u.
GLOW		Glow in the dark	-	-	-	-	0,18	5.100 u.

Les prix incluent l'impression numérique sur le corps.

① Prix sur demande.

Jusqu'à 1800 allumages

Conform EN 13869 85% Recyclé Conform ISO 9994

Emballage :



Emballage standard : barquette de 50 u.

Techniques d'impression : Emballage externe :



(DG) NUMÉRIQUE



600 ± 13,2 Kg



FABRIQUÉ EN ESPAGNE

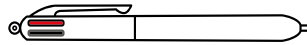

Taille mini pratique !

Standard - 2479



57



57**



57



03**



25



02

*48h non disponible en impression numérique
**Jusqu'à épuisement du stock

Commande minimale 300u.

Personnalisation :

BIC® J39 LIGHTER

2479

A/B SP: max. 4 col.

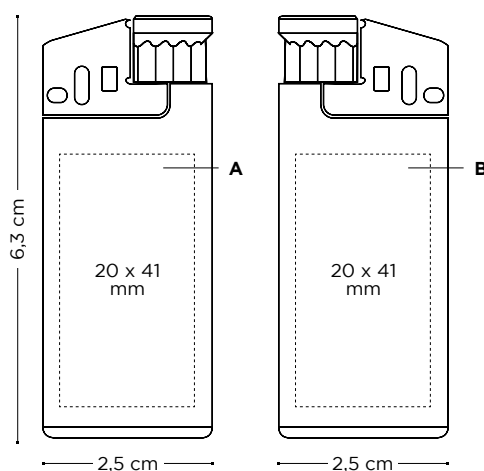



	Prix (€)				
BIC® J39 LIGHTER	300-599	600-1199	1200-2999	3000-5099	5100
2479					
SP	1,87	1,77	1,70	1,62	1,54

Frais d'impression supplémentaires par couleur et position

SP	0,13	0,13	0,13	0,13	0,09
-----------	------	------	------	------	------

Les prix incluent 1 couleur de marquage en sérigraphie sur une position.

Jusqu'à 1050
allumages 

Conform
EN 13869    Conform
ISO 9994

Emballage :



Emballage standard :
barquette de 50 u.

Techniques d'impression : **Emballage externe :**



(SP)
SÉRIGRAPHIE



600 ± 11,1 Kg



FABRIQUÉ
EN ESPAGNE

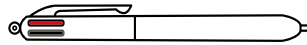

MATT SA

BIC® J39 LIGHTER DIGITAL
Standard - 2479



57



03 BR

100%

360°



57



MATT M



BR



BR GLOW

Commande minimale 600u.

Personnalisation :

BIC® J39 DIGITAL LIGHTER

2479

A DG: Numérique

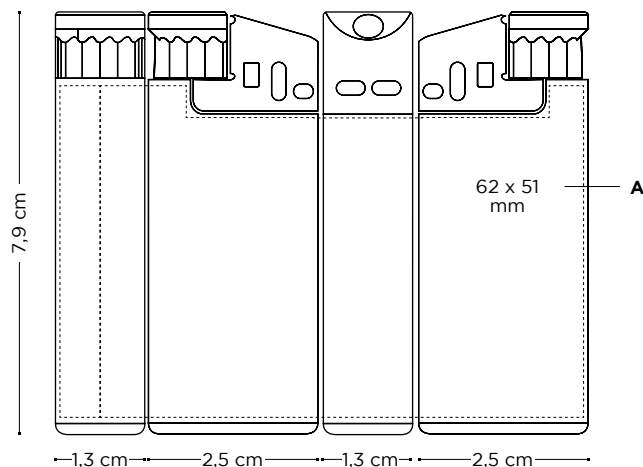

	Prix (€)				
BIC® J39 DIGITAL LIGHTER	300-599	600-1199	1200-2999	3000-5099	5100
2479					
DG	-	2,00	1,91	1,82	1,73

Finitions numériques - coût supplémentaire						Commande minimale		
BR	MATT	Brilliant ou matt	Gratuit			600 u.		
H	Holographic		-	0,26	0,26	0,26	0,18	600 u.
PUFFY	Impression Puffy		-	-	-	-	0,18	5.100 u.
M	Metallic		①					50.000 u.
UV	UV		-	-	-	-	0,18	5.100 u.
SA	Sandy		-	-	-	-	0,18	5.100 u.
PUFFY GLITTER	Puffy Glitter		-	-	-	-	0,18	5.100 u.
GLOW	Glow in the dark		-	-	-	-	0,18	5.100 u.

Les prix incluent l'impression numérique sur le corps.
① Prix sur demande.

Jusqu'à 1050 allumages

Conform EN 13869 85% Recyclé Conform ISO 9994

Emballage :



Emballage standard : barquette de 50 u.

Techniques d'impression :



(DG) NUMÉRIQUE

Emballage externe :



600 ± 11,1 Kg



FABRIQUÉ EN ESPAGNE

Simple et pratique à utiliser grâce à son bec de 6 cm.



2500 - 01



2500 - 03



Proposé dans un emballage individuel
Personnalisez-le à partir de 600 unités



Commande minimale 100u.

boîte carton individuelle:



Personnalisation :

BIC® MEGA LIGHTER

2500

A PD: max. 2 col.

B PD: max. 2 col.

B BP: Quadrichromie

C DG: Numérique

BP Texture: Quadrichromie

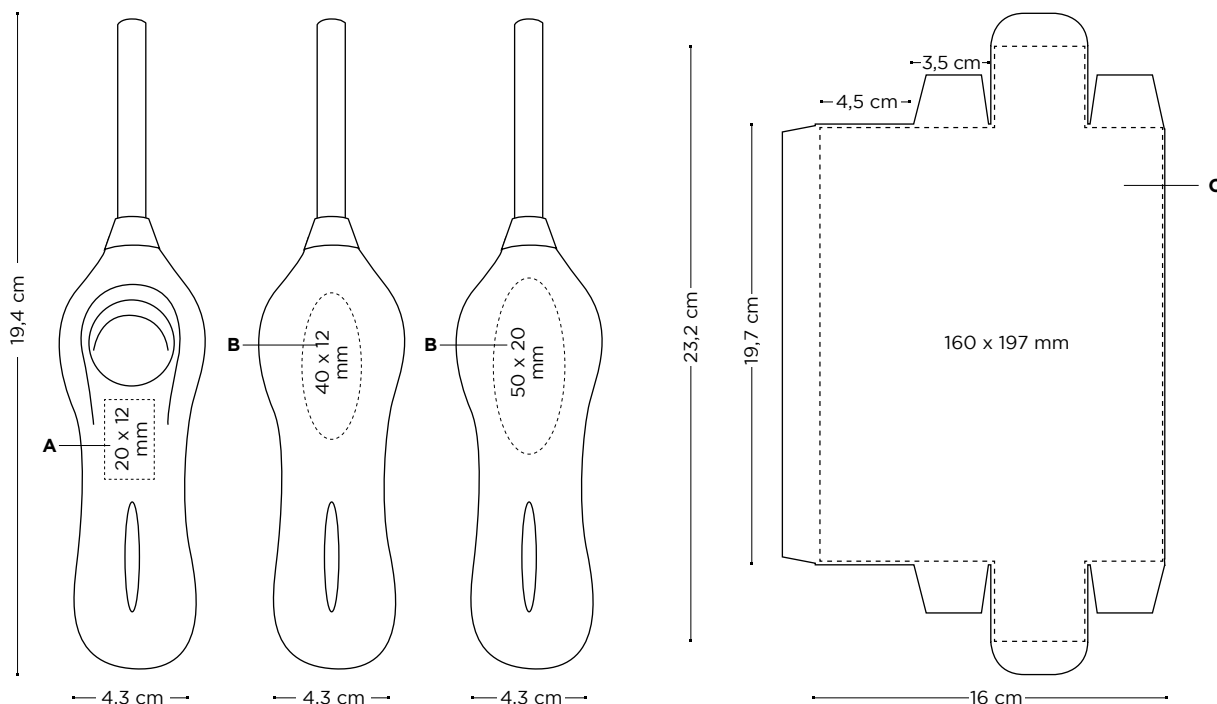

	Prix (€)					
BIC® MEGA LIGHTER	100-299	300-599	600-1199	1200-2999	3000-5099	5100
2500						
PD	5,22	4,98	4,73	4,47	4,29	-
BP	5,75	5,48	5,21	4,97	4,72	-

Frais d'impression supplémentaires par couleur et position

PD	1,39	1,36	1,32	1,28	1,28	1,28
BP Texture (non disponible en rouge)	1,19	1,15	1,11	1,07	1,06	1,06

Les prix incluent la tampographie monochrome sur un emplacement.
Les prix incluent l'impression britePix™ sur le corps.

Impression du logo client sur la boîte - coût supplémentaire

DG	-	-	0,99	0,84	0,69	0,49
-----------	---	---	------	------	------	------

Le prix inclut l'emballage totalement personnalisé en quadrichromie.

Jusqu'à 750 allumages

Conform ISO 22702

Emballage :



Emballage standard :
boîte carton individuelle

Techniques d'impression :



(PD) TAMPOGRAPHIE



(BP) britePix™



(DG) NUMÉRIQUE



Emballage externe :



100 ± 8,3 Kg

www.bicgraphic.eu

225



TOUTES LES COQUES sont livrées avec un **briquet blanc BIC® J25 lighter** !

Neon - 2386



2F*



1G*



5C*

100%



59*

*Jusqu'à épaisseur du stock

Commande minimale 100u.

Commande minimale 300u. **NOUVEAU**

Personnalisation :

BIC® STYL'IT LUXURY CASE
2386

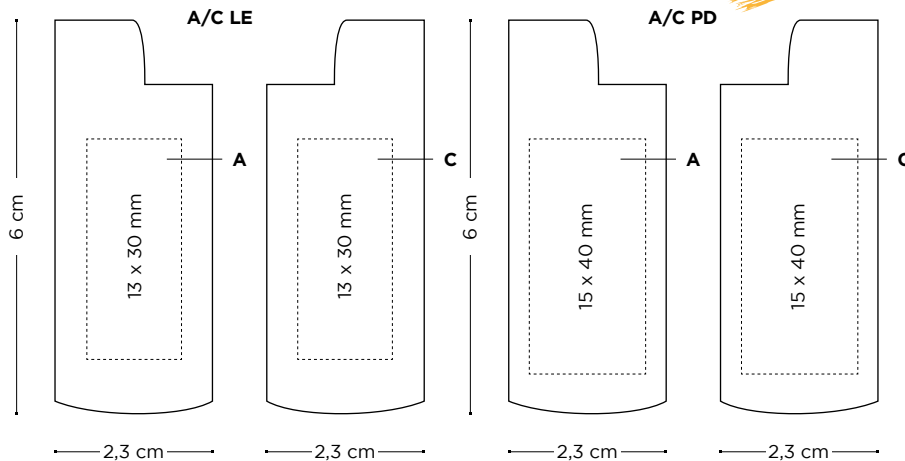

BIC® STYL'IT LUXURY CASE NEON 2386	Prix (€)			
	100-299	300-599	600-1199	1200
PD	3,02	2,66	2,52	2,39
LE	4,31	4,11	3,85	3,72

Frais d'impression supplémentaires par couleur et position

PD	0,29	0,25	0,18	0,18
LE	1,21	1,09	0,96	0,96

Les prix incluent une impression sur un emplacement avec la technique spécifiée.

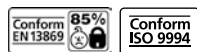

Emballage :



Emballage standard :
boîte de 10 unités

Techniques d'impression : Emballage externe :



(LE)
LASER



(PD)
TAMPOGRAPHIE



300 ± 6,1 Kg

Soft - 2153



01*

47*

02*

*Jusqu'à épuisement du stock

Metallic - 2161



47*

02*

*Jusqu'à épuisement du stock

100%

Commande minimale 100u.

Personnalisation :

BIC® STYL'IT LUXURY CASE
2153/2161
A/C LE

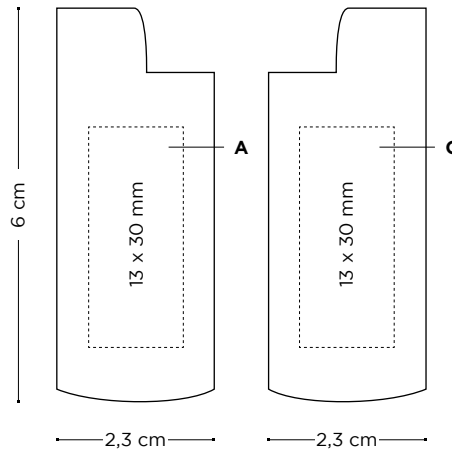

BIC® STYL'IT LUXURY CASE SOFT & METALLIC	Prix (€)			
	100-299	300-599	600-1199	1200
2153				
LE	4,52	4,37	4,18	4,02
2161				
LE	4,83	4,62	4,35	4,20
Frais d'impression supplémentaires par couleur et position				
LE	1,21	1,09	0,96	0,96

Le prix comprend 1 gravure laser sur 1 position.



Emballage :



Emballage standard :
boîte de 10 unités

Techniques d'impression : Emballage externe :



(LE)
LASER



300 ± 6,1 Kg

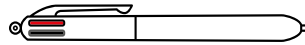

TOUTES LES COQUES sont livrées avec un **briquet blanc BIC® J25 lighter!**

3 faces personnalisables !

2156



Personnalisation :
BIC® ALUMINIUM FLAT CASE
2156

Commande minimale 300u.

Commande minimale 100u.

Commande minimale 100u.

A/C PD: max. 1 col.

A/B/C BP: Numérique

A/B/C LE

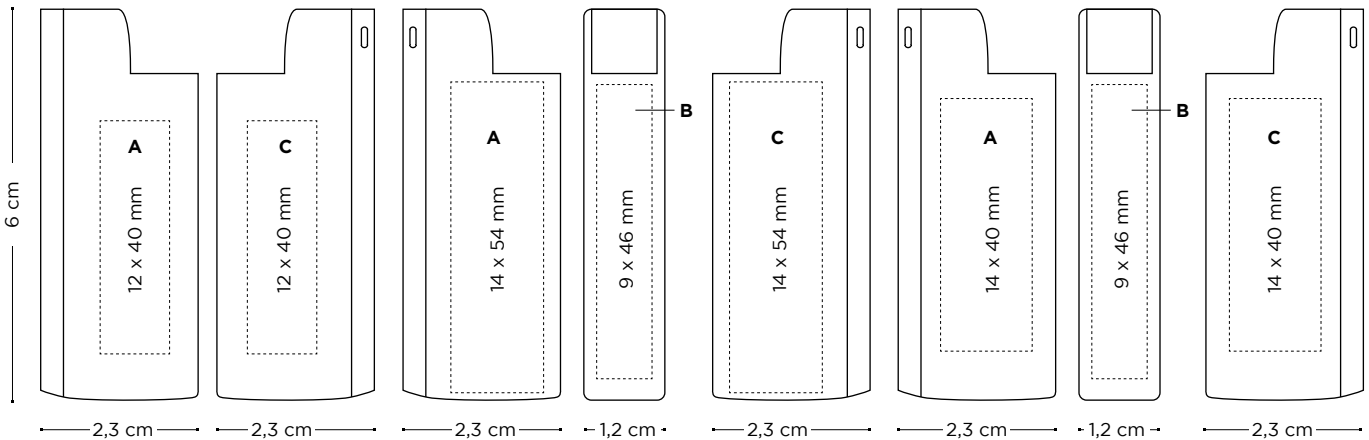

BIC® ALUMINIUM FLAT CASE	Prix (€)			
	100-299	300-599	600-1199	1200
2156				
PD	1,93	1,85	1,76	1,67
BP	2,14	2,06	1,95	1,86
LE	3,10	2,93	2,71	2,63

Frais d'impression supplémentaires par couleur et position				
PD	0,29	0,25	0,18	0,18
BP	0,25	0,22	0,20	0,19
LE	1,21	1,09	0,96	0,96

Les prix incluent une impression sur un emplacement avec la technique spécifiée.

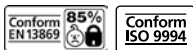

Emballage :

Techniques d'impression :

Emballage externe :



Emballage standard :
boîte de 10 unités

(PD) TAMOGRAPHIE (LE) LASER

(BP) britePix™



300 ± 6,9 Kg



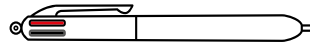

2398



Personnalisation:
BIC® CLIP CASE
2398

Commande minimale 300u.

A/C PD: max. 1 col.

Commande minimale 100u.

A/C BP: Quadrichromie

BP Texture: Quadrichromie

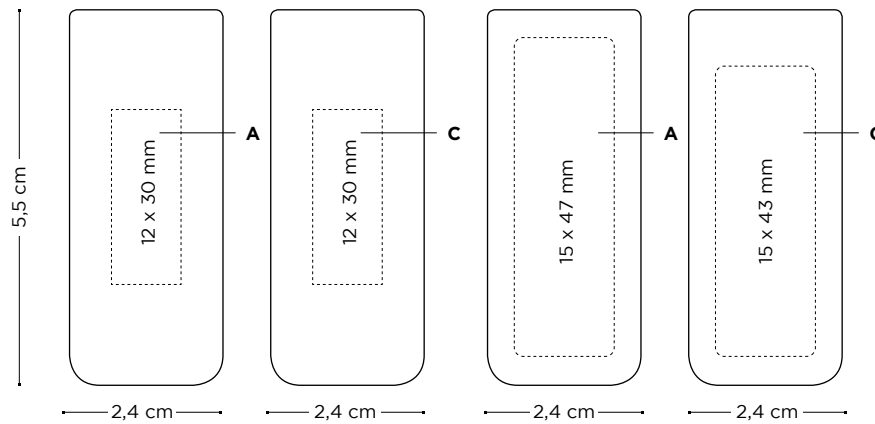

BIC® CLIP CASE 2398	Prix (€)			
	100-299	300-599	600-1199	1200
PD	1,55	1,44	1,32	1,29
BP	1,76	1,65	1,52	1,47

Frais d'impression supplémentaires par couleur et position

PD	0,29	0,25	0,18	0,18
BP Texture	0,19	0,17	0,15	0,14
BP	0,25	0,22	0,20	0,19

Les prix incluent une impression sur un emplacement avec la technique spécifiée.

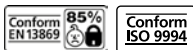

Emballage :



Emballage standard :
boîte de 10 unités

Techniques d'impression :



(PD)
TAMPOGRAPHIE



(BP) britePix™



Emballage externe :



300 ± 7,5 Kg



3D CASE

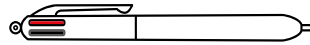

TOUTES LES COQUES sont livrées avec un briquet blanc BIC® J25 lighter !

Convertissez votre logo en 3D !

2395



Pour de plus amples détails, veuillez contacter notre service clients.

Commande minimale 1.200u.

Personnalisation :

BIC® 3D CASE

2395

A/C 3D: max. 6 col.

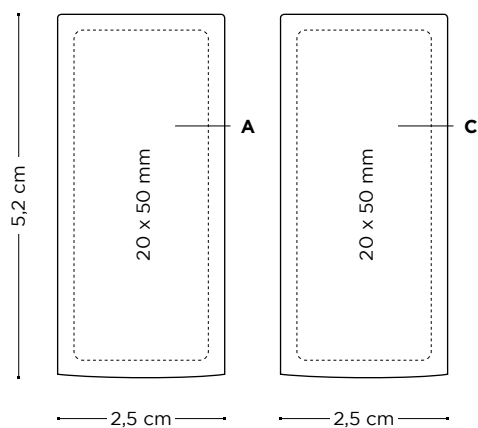

			Prix (€)
BIC® 3D CASE	1200-2999	3000-5099	5100
2395			
3D	4,74	4,49	4,27
Frais d'impression supplémentaires par couleur et position			
Gaufrage 3D sur la face B (1 couleur)	0,17	0,15	0,15
Couleurs supplémentaires gaufrées	0,10	0,09	0,09

Le prix inclut le gaufrage 3D en 1 couleur sur 1 emplacement.

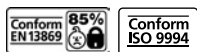

Emballage :



Emballage standard :
boîte de 50 unités

Techniques d'impression :



Embossage 3D

Emballage externe :



300 ± 7,5 Kg



POCKET ASHTRAY

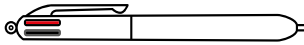

3850

6 formes à rabat disponibles



Réutilisable et hermétique

100%

Personnalisation :

BIC® POCKET ASHTRAY
Commande minimale 5.000u.

3850

A SP: max. 5 col.
(2 couleurs max. Pour les commandes inférieures à 20.000 uts)

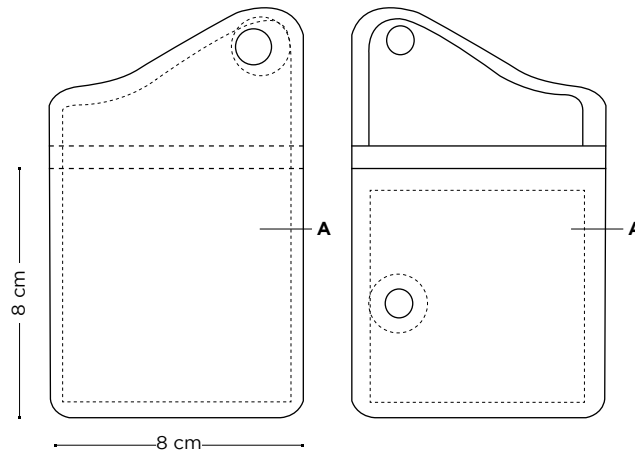

BIC® POCKET ASHTRAY	5000-9999	10000-19999	20000-24999	Prix (€)
3850				25000
SP	0,88	0,77	0,70	0,67

Frais d'impression supplémentaires par couleur et position	SP	0,05	0,04	0,03	0,03
--	----	------	------	------	------

Le prix inclut l'impression en 1 couleur et le texte légal.

Emballage :



Boîte de 10 unités. Chaque BIC® Pocket Ashtray est mis sous emballage individuel (cellophane).

Pour de plus amples détails, veuillez contacter notre service clients.
www.bicgraphic.eu

Techniques d'impression :



(SP)
SÉRIGRAPHIE

Emballage externe :



500 ± 5,5 Kg

Regardez la vidéo



Kraft - 3851

Produit respectueux
de l'environnement



100%

Personnalisation :

BIC® POCKET ASHTRAY KRAFT
Commande minimale 10.000u.

3851

A SP: max. 2 col.

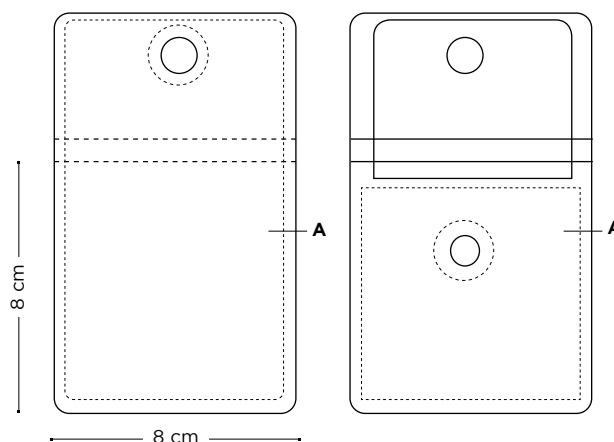

	Prix (€)			
BIC® POCKET ASHTRAY	5000-9999	10000-19999	20000-24999	25000
3851				
SP	-	0,94	0,85	0,82

Frais d'impression supplémentaires par couleur et position

SP	0,05	0,04	0,03	0,03
-----------	------	------	------	------

Le prix inclut l'impression en 1 couleur et le texte légal.

Emballage :



Boîte de 10 unités. Chaque BIC® Pocket Ashtray est mis sous emballage individuel (cellophane).

Pour de plus amples détails, veuillez contacter notre service clients.

Techniques d'impression :



(SP)
SÉRIGRAPHIE

Emballage externe :



500 ± 5,5 Kg

EMBALLAGES BIC®

Emballages BIC®

236

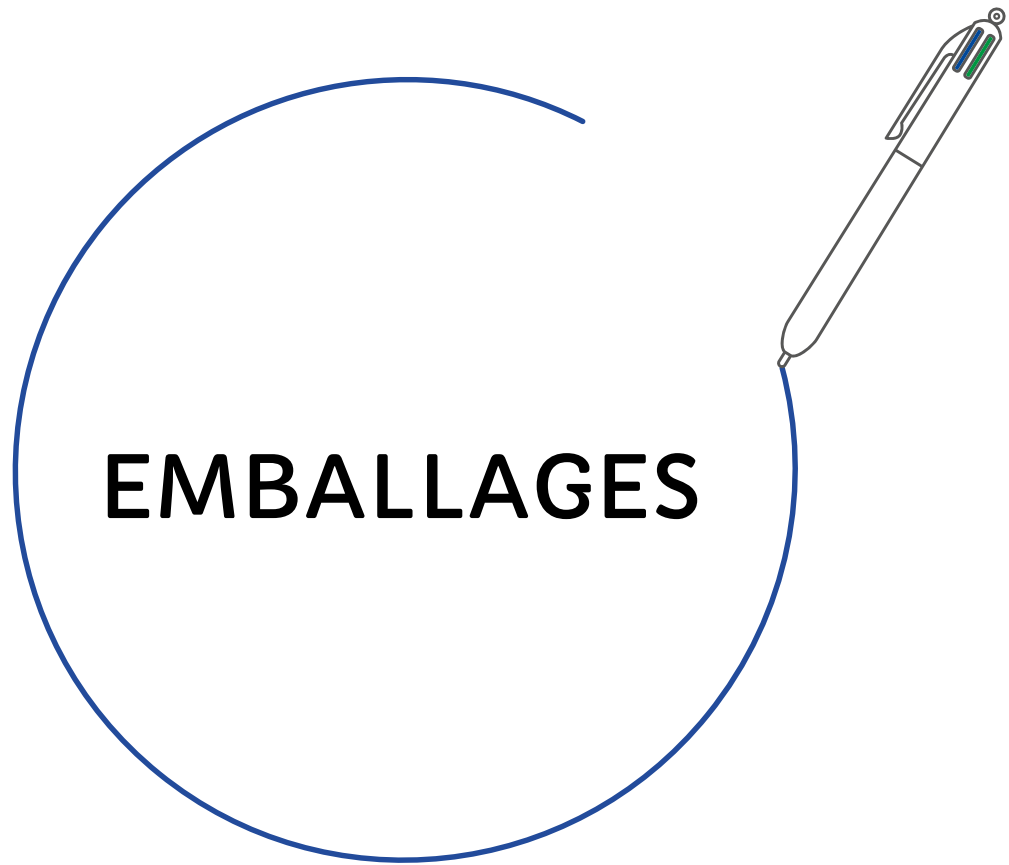

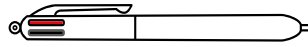

BIC ECO SLEEVE

985240

Pochette spéciale recyclée pour tous les instruments d'écriture BIC® à l'exception des crayons papier.



Prix (€)
0,22



RECYCLED
CARDBOARD



FABRIQUÉ
EN ESPAGNE



Emballage spécial pour stylos avec clip imprimé :

- MEDIA CLIC**
- WIDE BODY**
- CLIC STIC**
- ATLANTIS**
- SUPER CLIP**
- FINE STYLE**

Découvrez l'initiative
Freedom® :



BIC WINDOW BOX

985241

Emballage design haut de gamme pour tous les instruments d'écriture BIC® à l'exception des crayons papier.

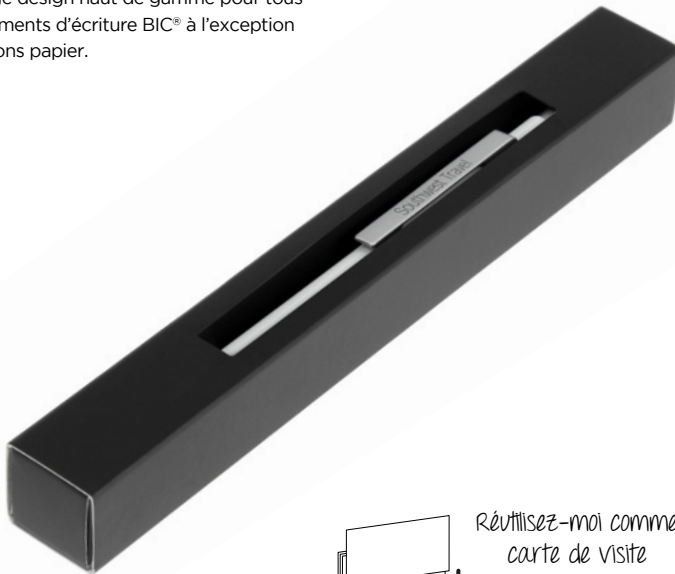

Prix (€)
1,30



FSC
www.fsc.org



FABRIQUÉ
EN ESPAGNE



Emballage spécial pour :

- METAL PENS**

Découvrez l'initiative
Freedom® :

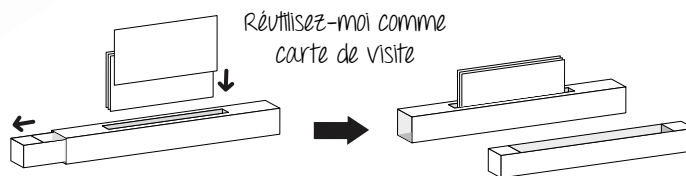

BIC PLASTIC POUCH

985242

Design spécial pour cet emballage qui s'adapte à tous les instruments d'écriture et pour 3 crayons papier.

Prix (€)
0,41



PLASTIQUE RECYCLABLE

FABRIQUÉ EN ESPAGNE



Utilisez-moi comme
marque-page



Emballages BIC

BIC MARKING SET

985243

Emballage conçu pour tous les types de stylos marqueurs.

Prix (€)
0,65



PLASTIQUE RECYCLABLE

FABRIQUÉ EN ESPAGNE

Emballage spécial pour stylos avec clip imprimé :

- BIC** 3 BRITE LINER
- BIC** 3 Velleda GRIP
- BIC** 3 MARK-IT
- BIC** 4 Velleda FINE



Utilisez-moi comme
marque-page



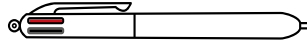

BIC CELLO WRAP

971634 - 971635 - 971636 - 971637

Emballage enveloppe en matière plastique résistante et transparente.



- 1. Cello wrap 1 unité
- 2. Cello wrap 2 unités.
- 3. Pack W.I. + Sticky.

Prix (€)

1 unité - 971634	0,16
2 unités - 971635	0,31
3 unités - 971636	0,46
4 unités - 971637	0,62

Non disponible pour les crayons papier ou les stylos métal. En raison des différents procédés d'impression, les couleurs de marquage sur les stylos et les blocs-notes peuvent légèrement différer.

BIC FROSTED POUCH (FOR 1 OR 2 ITEMS)

971640

Emballage transparent pour 2 instruments d'écriture.

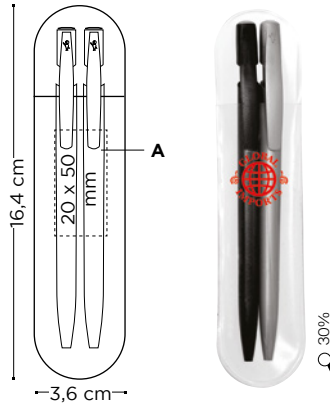

Prix (€)
0,79

Frais d'impression supplémentaires par couleur et position

SP 0,45

Disponible pour tous les instruments d'écriture, sauf crayons papier et porte-mines.

A SP: max. 1 col.



(SP) SÉRIGRAPHIE

Jusqu'à épuisement du stock

BIC BLACK VELVET POUCH 1 ITEM

974216

Emballage exclusif en velours pour 1 instrument d'écriture. Spécialement recommandé pour les stylos métal.

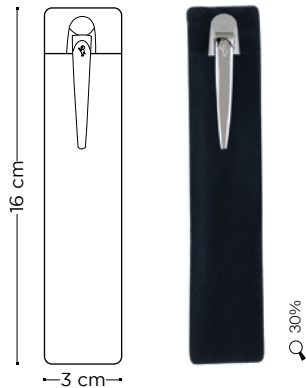

Prix (€)

1 article	0,47
-----------	------

Disponible pour tous les instruments d'écriture, sauf crayons papier et porte-mines.

BIC CARTON BLACK & SILVER COLOUR GIFT BOX

974218

Boîte pour tous les instruments d'écriture, sauf les crayons papier.

Prix (€)
0,31



Jusqu'à épuisement du stock

BIC BLACK TWO PIECE GIFT BOX FOR 1 ITEM

974214

Boîte pour tous les instruments d'écriture, sauf les crayons papier.

Prix (€)
1,24

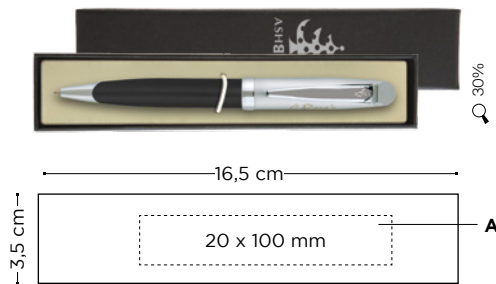

Frais d'impression supplémentaires par couleur et position

SP 0,45

Disponible pour tous les instruments d'écriture, sauf crayons papier et porte-mines.

A SP: max. 1 col.



(SP)
SÉRIGRAPHIE

Jusqu'à épuisement du stock

BIC SEE-THROUGH GIFT BOX (FOR 1 OR 2 ITEMS)

974599

Boîte pour tous les instruments d'écriture, sauf les crayons papier.

Prix (€)
1,79



Jusqu'à épuisement du stock

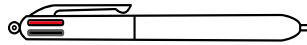

COUNT BOX

Petit
(pour 25 BIC® Clic Stic)
Moyen
(pour 50 BIC® Media clic ou similaire)
Grand
(uniquement pour 100 BIC® Ecolutions Evolution)

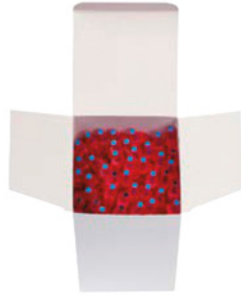

Prix (€)

Petit	0,77
Moyen	1,08
Grand	1,49

PLASTIC BAG

Petit
(pour 25 BIC® Media clic ou similaire)
Moyen
(pour 50 BIC® Media clic ou similaire)
Grand
(pour 100 BIC® Media clic ou similaire)



TRAY OF 10 WRITING INSTRUMENTS

Prix (€)
1,73

Prix (€)

Petit	0,52
Moyen	1,03
Grand	1,53

COUNT BOX 10U CASES



Prix (€)
0,90

COUNT BOX 10U CASES CHILD RESISTANT



Prix (€)
0,90

COUNT BOX 10U J25 CHILD RESISTANT



Prix (€)
0,70

BOX OF 50 METAL STYL'IT CASE



Prix (€)
4,07

Disponible pour la famille des BIC® Styl'it Luxury Lighter Case et des BIC® Aluminium Flat Case.

Disponible pour les briquets BIC® J26, BIC® J38 et BIC® J39.

Disponible pour le briquet BIC® J25.

Disponible pour les coques BIC® Clip Case et BIC® 3D Case.

BIC OUTER BOXES

Design spécial pour toutes les boîtes extérieures en lien avec tous les instruments d'écriture.



TRAY OF 50 BIC LIGHTERS



100% RECYCLÉ

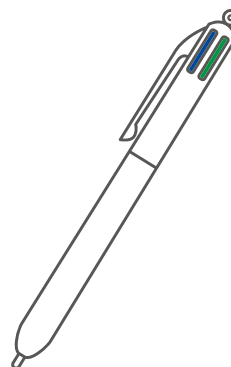

INFORMATIONS GÉNÉRALES

INFORMATIONS GÉNÉRALES

Commandez en toute simplicité!	242
Service d'impression en 48 heures	243
Informations générales sur les notes adhésives	244
Symboles et abréviations	245
Informations générales	246
Index Produits	248
Nuancier de couleurs	249

COMMANDEZ EN TOUTE SIMPLICITÉ !

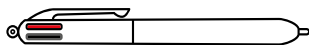

GAGNEZ DU TEMPS LORS DU CALCUL DE VOTRE PRIX FINAL REGARDEZ LA COLONNE DE QUANTITÉ POUR LE PRIX ET C'EST TOUT !

SANS FRAIS TECHNIQUE NI FRAIS D'ÉCRAN

Sauf les couleurs spécifiques - voir ci-dessous.

PERSONNALISATION INCLUSE

Les prix comprennent la personnalisation sur une position.

COULEUR SPÉCIALE POUR LES ATTRIBUTS

- Un choix "illimité" de couleurs de corps et d'attributs à partir de 10.000 pièces.
- Un stylo entièrement personnalisé dans les couleurs que vous souhaitez.
- Disponible pour une large gamme de produits.
- Un service supplémentaire à forte valeur ajoutée avec un délai de production additionnel réduit.
- Disponible pour les corps et attributs de: BIC® Round Stic®, BIC® Media Clic, BIC® Media Clic Grip*, BIC® Clic Stic, BIC® Super Clip, BIC® Wide Body™**, BIC® XS Finestyle

* Pour un corps et grip personnalisés MOQ de 20.000 pièces.

** La quantité minimum de commande pour personnaliser une section est de 25.000 unités.

- Frais technique par attribut. _____ 1.000,00 €
- Frais technique par attribut (renouvellement de commande) _____ 600,00 €
- Frais technique par attribut à partir de 100.000 unités _____ Gratuit

AUTRES CHARGES

Prototype (Transport non compris) _____ 129,00 €/commande*

- Disponible pour les instruments d'écriture BIC® (10 unités), les briquets BIC® (10 unités), ou les BIC® Flag Booklet (10 unités)
- Changement de cartouche d'encre si disponible (frais de manipulation) _____ 0,14 €/unité
- BIC® Sticky Notes: Frais pour une couleur spécifique faite sur mesure en tant que cinquième couleur _____ 105,00 €
- Modification et annulations de commandes après validation de la fiche de marquage (sujet à l'approbation de BIC Graphic Europe). Coût fixe par changement (coûts supplémentaires tels que l'outillage, les composants ou le produit fini à ajouter) _____ 70,00 €
- britePix™ personnalisation individuelle. _____ 65,00 €/commande**

* Non disponible pour les BIC® Sticky Notes et les briquets numériques avec finitions Puffy, Puffy Glitter, Metallic, Glow in the dark, Sandy, Holographic et UV.

** britePix™ personnalisation individuelle vous permet de changer les textes et image de votre photomontage, vous offrant un marquage personnalisé sur chacun des produits de votre commande. Toute information ou image devra être fournie sous un fichier Excel. En cas de modification de la position des textes et images (par rapport à la zone standard) un supplément sera facturé.

Pour les conditions générales de vente, veuillez vous référer à www.bicgraphic.eu

SERVICE D'IMPRESSION EN 48 HEURES

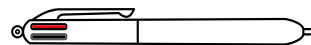

GRATUIT SUR PLUS DE 100 PRODUITS BIC® !

CONDITIONS DE L'OFFRE



INSTRUMENTS D'ÉCRITURE

- Sérigraphie 1 couleur (pour les produits en métal, seule la gravure laser est disponible)



BRIQUETS

- Impression 1 couleur



POSITION DE L'IMPRESSION

- 1 position standard



Informations générales

QUANTITÉ MAXIMALE

- Quantité indiquée en bas de la colonne de la liste de prix.

POUR LES COMMANDES EN LIGNE

- Le code promotionnel 900000480 doit être inclus dans le mot-clé.

PAYS ADMIS

- Pays de l'UE, Suisse et Norvège.

DÉTAILS SUPPLÉMENTAIRES DU PROGRAMME

- Dans le cas où l'article commandé n'est plus disponible en stock, nous vous offrirons un article alternatif d'une valeur égale ou supérieure. Dans ce cas, le délai de fabrication sera calculé à partir du moment où le client accepte l'article alternatif et approuve le nouveau design.

CONDITIONS DE LA COMMANDE

- L'approbation du design doit être reçue par BIC Graphic Europe avant 12:00 GMT+1, du lundi au vendredi.
- Les fins de semaine et les jours fériés locaux d'Espagne ne sont pas considérés comme des jours ouvrables.

EXPÉDITION

- BIC Graphic Europe ne peut garantir une date spécifique de livraison, seule la date d'expédition est garantie.

DIVERS

- Modifications du design - veuillez prévoir un délai supplémentaire pour les ajustements de design.
- Les comptes dont le crédit est bloqué ne sont pas acceptés.
- Cette promotion n'est pas applicable aux commandes retardées par de mauvaises conditions atmosphériques, des catastrophes naturelles ou d'autres événements hors du contrôle raisonnable de BIC Graphic Europe.

INFORMATIONS GÉNÉRALES SUR LES NOTES ADHÉSIVES

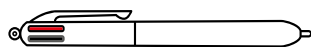

En raison de la nature du papier BIC® Sticky Notes, les résultats à l'impression auront un aspect mat, et non brillant. Les couleurs de référence choisies doivent être sélectionnées dans le guide d'une couleur spécifique. **Les BIC® Sticky Notes sont imprimés en quadrichromie (CMYK), une technique qui ajuste la couleur d'impression afin de correspondre aux références d'une couleur spécifique.**

Pour toute demande d'une couleur spécifique, nous pouvons proposer une impression avec une 5e couleur de ce Guide, à un prix majoré. Pour plus d'informations sur la manière d'obtenir la couleur correspondante la plus proche pour des impressions sur différents produits de notre catalogue, veuillez contacter notre service client.



ZONE D'IMPRESSION	FORMES SPÉCIALES D'ESTAMPAGE ET AUTRES PERSONNALISATIONS	IMPRESSION SHADOW OU FANTÔME
<p>Même si la partie supérieure du bloc de papier peut être imprimée (la partie adhésive), elle peut seulement être imprimée jusqu'à 60 % d'encre totale. Indépendamment de la zone adhésive, nous recommandons d'imprimer uniquement 30 % de la surface du produit afin de laisser de l'espace pour la prise de notes et d'éviter ainsi d'éventuelles problèmes d'adhésion de l'encre sur le papier.</p>	<p>Soyez le plus original ! Demandez vos blocs adhésifs BIC® Sticky Notes avec votre forme personnalisée ou adaptez-les en incluant votre propre logo sur le verso des blocs. Veuillez vérifier les conditions de ces formules spéciales avec votre contact habituel.</p>	<p>Les impressions Shadow ou fantôme sont disponibles sans surcoût. Les photographies, les dessins ou logos de grande taille qui couvrent la majorité de la surface centrale ont un meilleur rendu. Comme ces impressions sont très claires, les textes et numéros de téléphone ne sont pas recommandés en Shadow ou fantôme. Les meilleurs rendus sont obtenus à partir d'images tramées aux environs de 10 %.</p>

SYMBOLES ET ABRÉVIATIONS

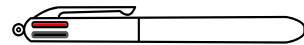

OPTIONS SPÉCIALES



Puffy glitter
Texture avec paillettes colorées.



Puffy Printing
Une personnalisation soulignée par notre encre « Puffy », pour donner un effet de relief à votre logo.



4-Colour Process
Permet la reproduction d'images de haute résolution. Idéal pour la reproduction de photographies. Original et attrayant



BR
Finition brillante.



Glow in the dark
Faites étinceller votre marque même dans le noir.



Metallic Finish
Crée des effets métalliques sur les images ou l'arrière-plan.



Holographic Finish
Transformez votre logo en 3D.



Matt
Finition mate.



UV
Finition extra brillante.



Sandy
Effet papier de verre, avec une texture granuleuse.



Digital
Quadrichromie haute définition, à 360° degrés et sur toute la longueur du corps du crayon.



britePix™
Votre message peut maintenant être imprimé en quadrichromie et d'une excellente qualité image afin de produire une impression durable et persistante de votre logo.



britePix™ Texture
britePix™ Texture apporte une nouvelle touche haut de gamme au concept britePix™. Désormais, vous pouvez non seulement voir tout en couleur, mais aussi le toucher !



britePix™ Digital
La solution pour une communication toute en couleur. Maintenant sur des corps en couleur



britePix™ personnalisation
Personnalisation britePix™ Personnalisez chaque unité dans une seule et même commande.

ABBREVIATIONS

SP = Sérigraphie
LE = Gravure laser
PD = Tampographie
DG = Quadrichromie
BP = britePix™
BP Texture = britePix™ Texture
MOQ = Quantité minimum de marquage
3D = 3D embossage

COULEURS D'ENCRE

Encre noire
 Jaune
 Encre Fluo
 Bleu Pastel
 Jaune Pastel
 Rose corail
 Encre bleue claire
 Encre verte claire
 Encre rose
 Encre bleue foncée
 Vert Pastel
 Violet Pastel
 Encre rouge
 Vert pomme
 Encre violette
 Orange
 Encre verte foncée

Easy Glide SYSTEM BIC® Easy-Glide system option
Offre une encre qui est 35 % plus lisse et plus épaisse que votre stylo à bille actuel.

MODES D'ECRITURE

M Medium
 F Fine
 B Bold
 Bille
MP Porte-mine
Ø 0,7 mm
PC Crayon
R Stylo à bille roulante
MK Marqueur
SP Stylo-plume
FS Surligneur
HL Feutre pointe fine
G Gel

AUTRES SYMBOLES

MIX & MATCH **Mix&Match**
Des centaines de couleurs de composants en stock pour la personnalisation complète des instruments d'écriture.

≥10.000 unités **Injection d'une couleur spécifique**
Choisissez la couleur exacte pour des décorations les mieux adaptées à votre logo.



QR code
scannez le QR code et visionnez la vidéo.



48-Hour
Service 48 h disponible.



Möbius Loop
Le produit contient des matériaux recyclés. Si vous voulez plus informations sur notre BIC® Ecolutions® et son mode de fabrication bicgraphic.eu/ie/sustainable-development.html



FSC
Produit fabriqué avec des matériaux respectant l'environnement, utilisant des matériaux renouvelables de conifères (polymères cellulosiques).



Pays d'origine



APP
Téléchargez l'application de BIC® Graphic et scannez les pages où figure cette icône.

NOUVEAU **Nouveau**



EN 13869
Règlement de sécurité des enfants pour les briquets.



ISO 22702
Cette norme certifie la qualité de tous les briquets utilitaires.



ISO 9994
Normes de sécurité internationales pour les briquets de poche.



Notes adhésives
Nombre de pages.



Informations sur l'emballage
500 : 35 kg



BIC® Boy
Le bonhomme BIC iconique est embossé



BIC® Mega Lighter
usage quotidien du BIC® Mega Lighter.



Jusqu'à 1400 allumages **Nombre d'allumages**



Protection anti-bactérienne



Protection sur toute la surface du stylo



Protection à vie



Testé par un protocole antibactérien

DIMENSIONS Les dimensions publiées de tous les produits correspondent à la taille maximale, quelle que soit la position du dessin.

INFORMATIONS GÉNÉRALES

INFORMATIONS CONCERNANT LES FICHERS

Veuillez charger votre fichier sous l'un des formats suivants:

- Un fichier électronique avec le dessin graphique
- Et un fichier différent pour le texte. Pour un marquage au laser individuel, les textes devront être fournis uniquement sous format Excel® (.xls).

PROPRIÉTÉS DU MATÉRIEL GRAPHIQUE

Envoyez-nous votre matériel graphique dans un des types de fichiers suivants :

- JPG / 350 dpi non comprimé à la taille réelle de marquage (seulement images, sans texte)
- PDF / vectorisé
- Illustrator® CC / vectorisé
- Photoshop® CC / avec les calques
- Fichiers ZIP

Il est important que vous nous fassiez parvenir les informations dans l'un de ces formats afin de traiter au mieux votre commande et d'obtenir un résultat final optimal. Si la création du client ne rentre pas dans notre format, nous modifierons en conséquence.

Type de caractères :

- Tous les types de caractères doivent être convertis en image. Vérifiez les tailles minimales des types et les épaisseurs de trait. Veuillez contacter le service clientèle pour plus d'informations.

SPÉCIAL POUR LES PRODUITS D'ÉCRITURE

La zone d'impression disponible dépend de la technique d'impression requise.

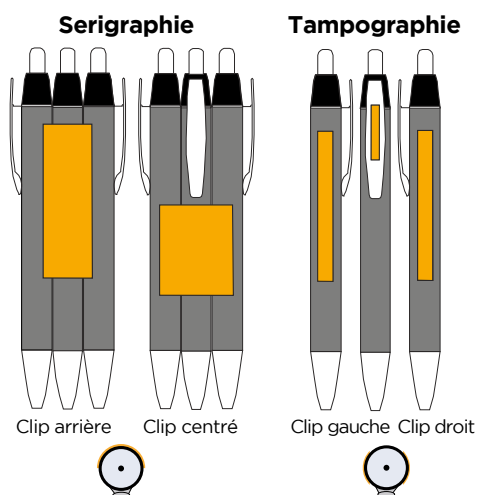

SPÉCIAL POUR LES BRIQUETS (J25, J26, J38 ET J39)

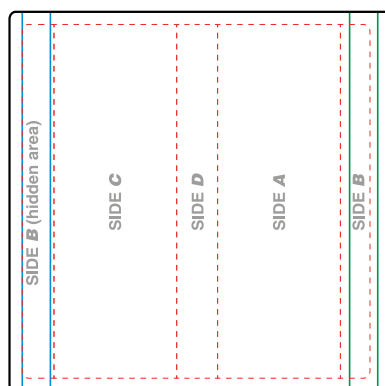

- Pour toute demande de couleur directe Pantone, nous pouvons proposer une impression avec une 5e couleur disponible dans ce catalogue, à un prix majoré. Pour plus d'informations sur la manière d'obtenir la couleur correspondante la plus proche pour des impressions sur différents produits de notre catalogue, veuillez contacter notre service client.

PARAMÈTRES TECHNIQUES POUR CHACUN DES TYPES D'IMPRESSION

	SERIGRAPHIE / TAMPOGRAPHIE		ESTAMPAGE / EMBOSSAGE		LASER	
Texte positif minimum	6 pt (2.1 mm)	6 Points text	10 pt (3.5 mm)	10 Points text	6 pt (2.1 mm)	6 Points text
Texte négatif minimum	9 pt (3.1 mm)	9 Points text	15 pt (5.25 mm)	15 Points	NON RECOMMANDÉ	
Épaisseur minimale des lignes positives	0.4 pt (0.14 mm)	—————	1.5 pt (0.5 mm)	—————	0.3 pt (0.1 mm)	—————
Épaisseur minimale des lignes négatives	0.5 pt (0.176 mm)	=====	2 pt (0.706 mm)	=====	0.5 pt (0.17 mm)	=====
Épaisseur minimale des demi-teintes	1.5 pt (0.5 mm)	—————	PAS POSSIBLE		PAS POSSIBLE	
Pourcentage de demi-teinte	50%	—————				
	NOTES ADHÉSIVES			NUMÉRIQUE / TRANSFERT DIGITAL		
Texte positif minimum	4 pt (1.4 mm)	4 Points text	4 pt (1.4 mm)	4 Points text		
Texte négatif minimum	5 pt (1.75 mm)	5 Points text	7 pt (2.4 mm)	7 Points text		
Minimum text for half tone	7 pt (2.4 mm)	7 Points text	1.5 pt (0.5 mm)	7 Points text		
Épaisseur minimale des lignes positives	0.3 pt (0.1 mm)	—————	0.25 pt (0.08 mm)	—————		
Épaisseur minimale des lignes négatives	0.5 pt (0.17 mm)	=====	0.5 pt (0.17 mm)	=====		
Épaisseur minimale des for lines in half tone	0.5 pt (0.17 mm)	—————	0.5 pt (0.17 mm)	—————		
Minimum half tone values	C: 5% / M: 5% / Y: 15% / K: 5%			C: 8% / M: 8% / Y: 12% / K: 8%		
	<input type="radio"/> <input type="radio"/> <input type="radio"/> <input type="radio"/>			<input type="radio"/> <input type="radio"/> <input type="radio"/> <input type="radio"/>		
	britePix™					
Texte positif minimum	6 pt (2.1 mm)	6 Point text				
Texte négatif minimum	7 pt (2.4 mm)	7 Point text				
Épaisseur minimale des lignes positives	0.4 pt (0.14 mm)	—————				
Épaisseur minimale des lignes négatives	0.5 pt (0.17 mm)	=====				
Épaisseur minimale des demi-teintes	1 pt (0.35 mm)	—————				
Pourcentage de demi-teinte						

COULEURS SPÉCIALES D'IMPRESSION

COULEURS EXACTES QUI REQUIÈRENT UNE COUCHE DE FOND BLANCHE

Plusieurs références de couleur requièrent un aplat blanc lorsqu'elles sont imprimées sur des surfaces foncées (noir, bleu foncé, rouge) pour pouvoir obtenir le résultat souhaité par le client.

- Si le produit permet seulement une impression, le représentant du service clients devra prévenir le client que le résultat de la couleur imprimée sera approximatif.
- Si le produit permet une impression supplémentaire, le représentant du service clients offrira au client la possibilité d'obtenir la couleur exacte avec un aplat blanc (moyennant majoration du prix).

NUANCIER DE COULEURS

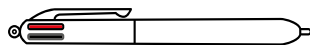

01 Blanc	1E Blanc recyclé	57 Blanc opaque	3C Blanc perlé	01 Blanc BIO	1T Blanc poli	51 Transparent	69 Blanc givré	2E Blanc givré recyclé	1R Blanc clair	
8D Jaune pastel	2F Jaune poli	8G Jaune light	12 Jaune	8T Jaune poli	63 Jaune givré	012 Jaune BIO	4D Jaune clair	6F Marron clair	29 Or bronzé	26 Or
1G Orange acide	10 Orange	6P Orange poli	90 Orange pastel	71 Orange givré	92 Orange clear	3J Orange corail				
03 Rouge	3T Rouge poli	8E Rouge recyclé	87 Rouge clair	03 Rouge BIO	66 Rouge givré	4G Rouge métallisé	08 Bordeaux			
14 Rose	3G Rose clair	3H Corail rose	5C Pétillant rose	95 Rose clair	6T Rose poli	2C Rose métallisé	1P Rose fluo			
2M Violet	84 Pourpre paste	13 Lilas	39 Pourpre givré	4B Violet givré	7G Violet métallisé	2D Pourpre	93 Pourpre foncé clair	9T Pourpre poli		
8C Citron vert	85 Vert pastel	68 Vert givré	6C Vert herbe	88 Vert clair	59 Vert pomme	2G Vert acide	5P Vert poli	82 Vert foncé glacé	72 Vert clair	5G Vert clair
5T Vert poli	05 Vert	20 Vert foncé	7E Vert foncé recycle	88 Vert foncé clair	05 Vert BIO	2B Jungle	3B Jungle givré			
83 Bleu pastel	3D Bleu caraïbe	4T Bleu caraïbes poli	4R Bleu caraïbes clair	34 Bleu métallique	86 Bleu clair	67 Bleu glacé	24 Bleu clair	04 Bleu BIO	04 Bleu	40 Bleu foncé givré
34 Bleu foncé métallisé	1D Bleu foncé métallisé	7R Bleu marine	89 Bleu marine clair	25 Bleu foncé	07 Bleu marine	10E Bleu marine recyclé	50 Bleu royal	7T Marine		
35 Chrome	47 Argent	75 Argent métallisé	18 Metal	06 Gris clair	27 Gris foncé	8L Gris poli	91 Noir clair	65 Noir givré	8H Gris foncé frost	8A Bronze
02 Noir BIO	2T Noir poli	02 Noir	3E Noir recyclé							

Les couleurs ci-dessus ne sont qu'à titre indicatif uniquement. La couleur réelle peut varier légèrement selon le produit.

